

1974 FORD Torino

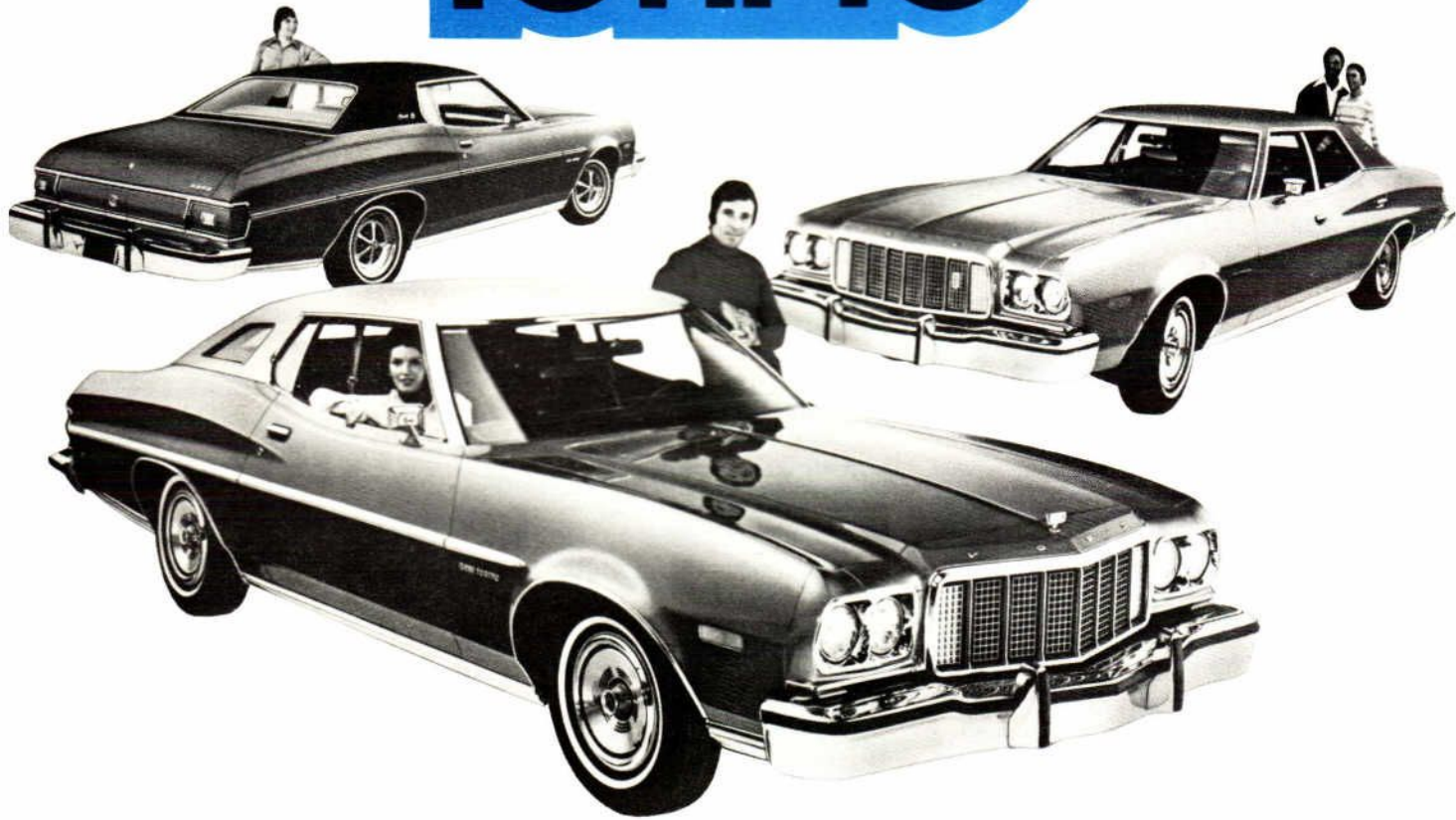

Gran Torino a distinctively solid car
Gran Torino Brougham a new level of luxury
Gran Torino Sport a higher level of excitement

1974 Torino—well styled, solid, good riding, quiet. The crisp new styling of the Ford Torino marks the third consecutive year that Torino has had its appearance refined to meet the demands of the fast expanding mid-size market segment. Buyers in this market are influenced by distinctive styling and good value. Torino has them both. Torino has a broad value-oriented product offering which includes: economy, luxury and sporty models plus a *complete* line of optional equipment.

Torino . . . as much car as anyone will ever need!

FORD Gran Torino for '74

Gran Torino

New Exterior Styling

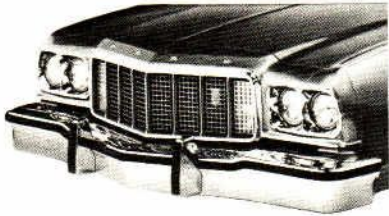

Distinctive front end styling features corrosion-resistant grille, brightly styled chromeplated moldings and dual headlamps.

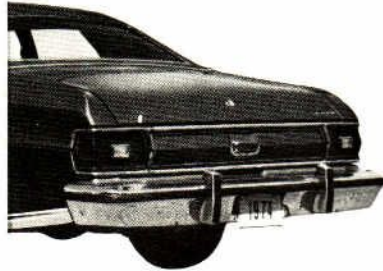

Clean taillight design with integral rear side marker lights and backup lights centered in the taillight, offer function and beauty.

New Interior Styling



New levels of luxury. The Gran Torino interior features cloth-and-vinyl seat and door trim and is fully carpeted. The seats combine flexible springs attached to a rugged, welded frame construction with deep foam padding—to provide better support and reduce fatigue.

Gran Torino Brougham



The Brougham models feature a higher level of interior luxury:

- Split-bench front seat
- Dual fold-down center armrests
- Luxury Westminster cloth seat and door trim
- Rich woodtone appliques on the instrument panel
- Deep cut-pile carpeting
- Deluxe 2-spoke steering wheel
- Self-regulating electric clock



Brougham exterior features include such style and value features as:

- full vinyl roof
- wide vinyl insert body-side molding color-keyed to the roof

- stylish opera window (on 2-door models)
- distinctive hood ornament
- steel-belted white sidewall radial ply tires

Gran Torino Sport



The Gran Torino Sport is easily identified by its "sport" grille, its standard turbine wheel covers and white sidewall steel-belted radial ply tires. Other exterior styling touches include dual outside color-keyed left- and right-hand remote controlled mirrors.



Inside, the Gran Torino Sport features full performance instrumentation (tachometer, trip odometer, engine gauges, oil, ampere, temperature, fuel—and an electric clock) super-soft vinyl seat trim; cut-pile carpeting and a choice of Flight Bench seating or bucket seats at no extra cost.

where the action is!

1974

Model Line-Up

Low Series—Torino

- 2-Dr. Hardtop
- 4-Dr. Pillared Hardtop

Middle Series—Gran Torino

- 2-Dr. Hardtop
- 4-Dr. Pillared Hardtop

Luxury Series—Gran Torino Brougham

- 2-Dr. Hardtop
- 4-Dr. Pillared Hardtop

Sport Series—Gran Torino Sport

- 2-Dr. Hardtop

Wagon Series

- Torino
- Gran Torino
- Gran Torino Squire

10 Models in 1974

Engines & Transmissions

Torino Power Team Selections

All 1974 Torino models feature upgraded standard power teams with 302 CID 2V V-8 and 3-speed, fully synchronized manual transmission with column shift standard. The complete lineup is as follows:

Engine	TRANSMISSION		REAR AXLE RATIOS					
	3-Speed	Cruise-O-Matic	3-SPEED MANUAL			CRUISE-O-MATIC		
			Std.	Opt.	Traction-Lok	Std.	Opt.	Traction-Lok
ALL MODELS EXCEPT STATION WAGONS								
302 CID 2V (b) V-8	Std.	Opt.	3.00*	NA	3.00*	3.00*	NA	3.00*
351 CID 2V V-8 Opt.	NA	(2) Opt.	NA	NA	NA	2.75* (a) (3)	3.25*	2.75*(a) 3.25*
351 CID 4V (b) V-8 Opt. (1)	NA	(2) Opt.	NA	NA	NA	3.25*	NA	3.25*
400 CID 2V V-8 Opt.	NA	(2) Opt.	NA	NA	NA	2.75* (a)	3.25* (a)	3.25* (a) 2.75* (a)
460 CID 4V V-8 Opt.	NA	(2) Opt.	NA	NA	NA	2.75* (a)	3.25* (a)	3.25* (a) 2.75* (a)

*Available transmissions and ratios with air conditioning
(1) Available only on two-door models (2) Required Option
3) 3.00 standard on four-door models with 351 CID engine

(a) 3.00 Standard in California
(b) NA California
NA—Not Available

The 1974 Torino fuel tank capacities are:

Torino—26.5 gal.

Wagons—21.2 gal.

Solid-State Ignition, which eliminates the need for points or condenser replacement is standard on the 400 and 460 engines.

1974 Torino Standard Tire Availability

Torino tire offerings for 1974 include a choice of bias-belted and steel-belted

radial ply tires. Raised white-letter tires also available.

Model and Engine Application	302 CID 2V 8-CYL.	351 CID 2V 8-CYL.	351 CID 4V 8-CYL.	400 CID 2V 8-CYL.	460 CID 4V 8-CYL.
TORINO 2-Door Hardtop—Formal Roof 4-Door Pillared Hardtop 4-Door Station Wagon	G78 BSW G78 BSW H78 BSW	G78 BSW G78 BSW (a) H78 BSW	G78 BSW NA NA	G78 BSW (a) G78 BSW (a) H78 BSW	H78 BSW H78 BSW H78 BSW
GRAN TORINO 2-Door Hardtop—Formal Roof 4-Door Pillared Hardtop 4-Door Station Wagon	G78 BSW G78 BSW H78 BSW	G78 BSW (a) G78 BSW (a) H78 BSW	G78 BSW (a) NA NA	G78 BSW (a) G78 BSW (a) H78 BSW	H78 BSW H78 BSW H78 BSW
GRAN TORINO BROUGHAM 2-Door Hardtop—Formal Roof 4-Door Pillared Hardtop	HR78 WSW HR78 WSW	HR78 WSW HR78 WSW	HR78 WSW NA	HR78 WSW HR78 WSW	HR78 WSW HR78 WSW
GRAN TORINO SQUIRE 4-Door Squire Station Wagon	HR78 WSW	HR78 WSW	NA	HR78 WSW	HR78 WSW
GRAN TORINO SPORT 2-Door Hardtop—Formal Roof	HR78 WSW	HR78 WSW	HR78 WSW	HR78 WSW	HR78 WSW

HR—steel-belted radial ply tires (a) H78 BSW standard on models with air conditioner

BUILT-IN QUALITY gives Torino a smooth



Contributing to Torino's stability—a wide tread—over five feet wide front and rear.



Add to the wide tread—a long wheelbase. 114 inches for 2-door models and 118 inches for 4-door models. Two factors which contribute to Torino's outstanding ride.

Body Dimensions

TORINO MODEL <small>All dimensions are in inches unless otherwise specified.</small>	4-Door Pillared Hardtop		2-Door Hardtop		Station Wagons	
	Low Series	High Series	Low Series	High Series	Low Series	High Series
GENERAL						
Wheelbase	118	118	114	114	118	118
Tread—Front	63.4	63.4	63.4	63.4	63.4	63.4
—Rear	63.5	63.5	63.5	63.5	63.5	63.5
Height—Overall	53.5	53.5	53.0	53.0	54.9	54.9
Length—Overall	215.4	217.6	211.4	213.6	219.1	221.3
Width—Overall	79.3	79.3	79.3	79.3	79.0	79.0
—At center pillar	76.8	76.8	77.2	77.2	76.8	76.8

quiet ride

Strong Stable Easy Handling



Torino's "Stabul"

rear suspension reduces side sway—increases cushioning.

Torino's "Stabul" rear suspension resists lateral or side-to-side sway and permits the coil springs to give optimum cushioning. The lower control arms are splayed and the shock absorbers are angle mounted (see illustration). These work together to form a brace which resists side sway yet does not take away the cushioning effect of the coil springs. The result: an effectively stable and comfortable ride.

Computer Tuned Front Suspension

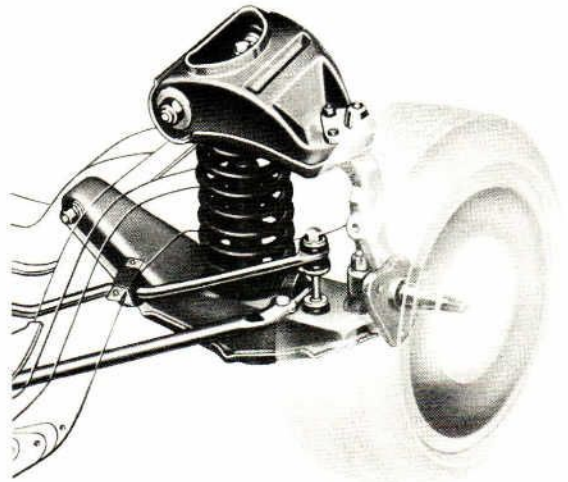

Torino's front suspension is computer-selected to match the weight/ride requirements. The coil springs are tailored for Torino—depending on car model, engine selection and optional equipment, which vary.

Drag struts and control arms are *rubber insulated*.

This combination helps reduce road shock before it reaches the passenger compartment—adding to the smooth ride.

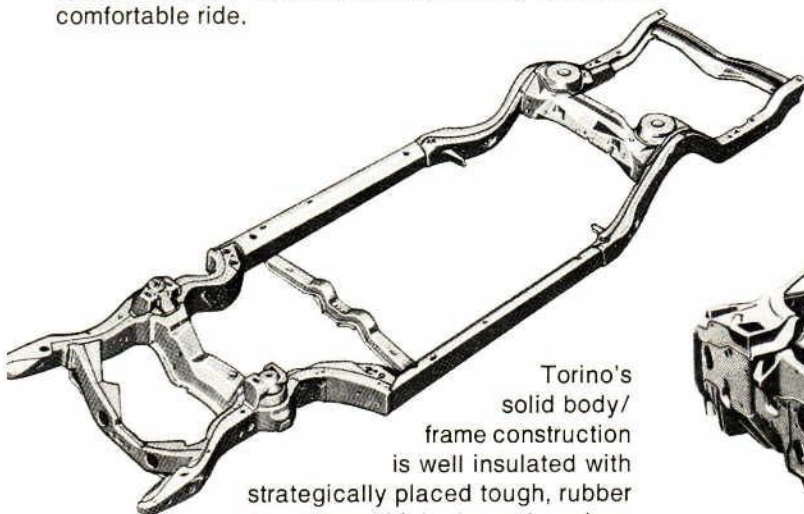

Torino's solid body/frame construction is well insulated with strategically placed tough, rubber insulators which also reduce jars, noise and harshness.

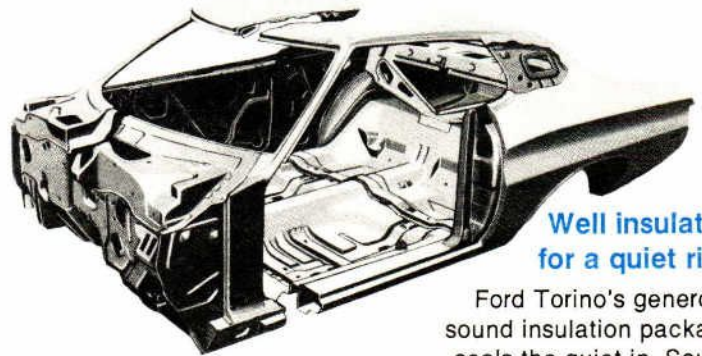

Well insulated for a quiet ride

Ford Torino's generous sound insulation package seals the quiet in. Sound deadening materials are strategically placed to provide an exceptionally quiet ride.

Ford Torino Quality is built in!

FORD Torino Wagons



Preferred by many
because Ford Torino
Wagons are sized right.

SelectShift Cruise-O-Matic is standard on
all Torino Wagons for 1974.

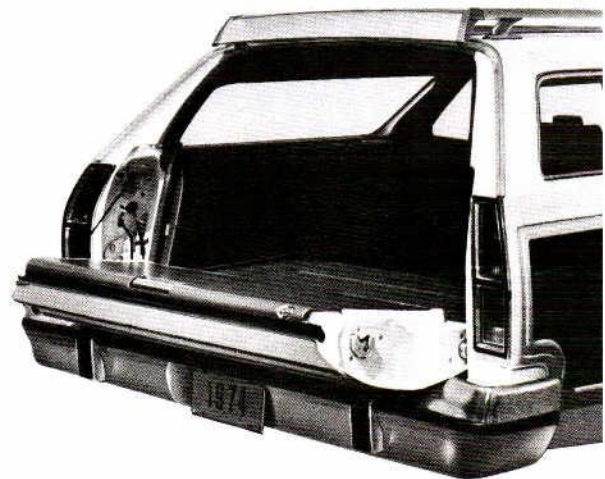
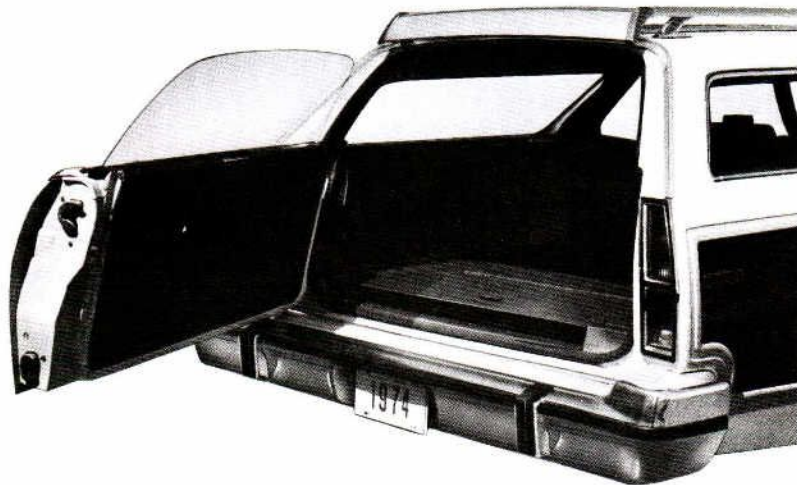

Popular
Standard
Feature

3-Way Magic Doorgate

Still leading in popularity—Torino's 3-Way Magic Doorgate. Opens like a door with the window up or down. Opens like a tailgate for long loads.

the GREAT mid-size station wagon



Above all— spaciousness

Torino's big cargo area has nearly 85 cubic feet of space—plus over 8 feet of lockable extra space for stowage under the big flat floor.

Width between the wheel wells is over 48 inches (will take standard plywood sheets). With the tailgate down—over 109 inches of long, flat cargo floor to handle long loads.



Power front disc brakes are standard on Torino Wagons.



WSW steel-belted radial ply tires—standard on the Gran Torino Squire

Power tailgate window—standard on the Gran Torino Squire, and returning again this year is the optional rear window electric defroster

☆ **New for '74**—station wagon spare tire extractor. This option permits easy removal of the spare tire from its stowage compartment, and is part of the convenience group.

Wheel Cover Options



DELUXE*

LUXURY

Available as options on all models except as footnoted.

*Std. on Gran Torino Brougham models

Adding a touch of luxury to wagons—the Gran Torino Squire Brougham option available for the *first* time!

Included in this new luxury option are:

Interior:

- split-bench seat with dual fold-down center armrests
- super-soft vinyl seat and door trim
- plush 25-oz. cut-pile carpeting in the passenger compartment
- cut-pile carpet on the load floor
- electric clock

a host of **Torino Options**



The new optional opera window adds elegance to the Gran Torino 2-door and Sport models, standard on Gran Torino Brougham 2-door model.

AM/FM stereo radio with tape deck—or AM or AM/FM stereo. The latter two include four speakers for full surround stereo listening.

SelectAire air conditioning provides controlled temperature and humidity comfort. Automatic Temperature Control is also available. Be sure to recommend either system. Tinted glass provides cooling and it's easy on the eyes.

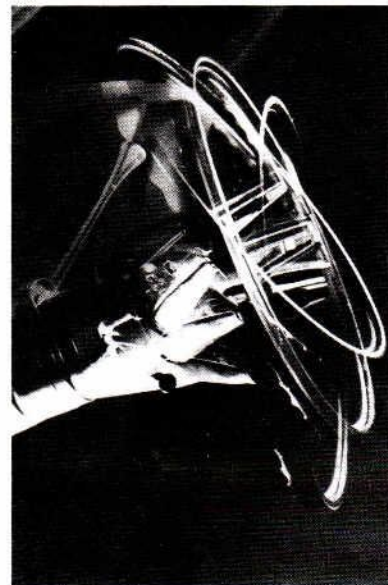

The tilt steering column option allows the steering wheel to be adjusted for individual comfort and driving ease.

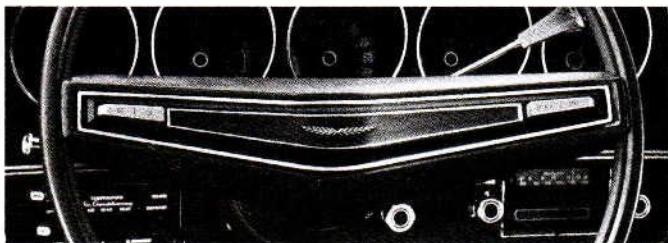

Fingertip Speed Control. A great comfort and convenience feature for highway driving. Disengages at the touch of the brake pedal. A "Rim-Blow" deluxe two-spoke steering wheel is included.

Exterior Decor Group



Available only on the Gran Torino hardtop and 4-door pillared hardtop. Content:

- full-length fender peak paint stripes
- deluxe wheel covers
- full vinyl roof

(The paint stripes are available as a separate option for the base Torino Series and Gran Torino Brougham models.)

Light Group

A new lineup of lighting equipment for safety and convenience is available on all models.

- under instrument panel courtesy lights
- glove box light
- instrument panel ash tray light
- rear door courtesy light switch
- luggage compartment or wagon cargo area light
- engine compartment light
- parking brake warning light
- dual beam map light
- lights-on warning buzzer
- illumination of headlamp switch nomenclature

Luggage Compartment Trim



This option offers a completely finished luggage compartment for good looks and luggage protection. It includes:

- carpeted floor
- carpeted spare tire cover
- side lining boards

The Convenience Group includes:

- left- and right-hand remote controlled mirrors. The right-hand mirror is controlled from the instrument panel
- interval windshield wipers
- right-hand visor vanity mirror (also includes spare tire extractor on wagons)

FORD Torino^{for}'74



TORINO

**Look closely—
at a really solid car.**

The closer you look, the more you appreciate the solid value beautiful Torino offers. Room for six adults with handling ease of a mid-size car. And a choice of 10 luxurious new models including three smart Station Wagons.

TORINO INDEX

1974 TORINO MODELS

Complete Model Line-Up.....	2
TORINO.....	4
GRAN TORINO.....	5
GRAN TORINO BROUGHAM.....	6
GRAN TORINO SPORT.....	7
TORINO STATION WAGON.....	8
GRAN TORINO STATION WAGON.....	8
GRAN TORINO SQUIRE WAGON.....	9

BODY FEATURES

Body Construction.....	14
Body Insulation.....	15
Body Sealing Material.....	15
Bumper Jack System.....	17
Doors.....	16
Doors Handles and Armrests.....	16
Fuse Panel.....	17
Grille.....	17
Guard Rails, Steel.....	See Section A, p. 6
Heating.....	16
Hood.....	17
Instrument Panel.....	16
Luggage Compartment.....	15
Paint Process, Six-Step.....	See Section A, p. 5
Restraint System, 3-Point Occupant. See Section A, p. 6	
Rust Prevention.....	14
Seats.....	17, 18
Starter Interlock and Warning Light Buzzer.....	See Section A, p. 6
Station Wagons.....	8, 9, 10
Ventilation.....	17
Windows.....	16
Windshield Wipers, Concealed.....	16

CHASSIS FEATURES

Brakes, Front Disc/Rear Drum.....	14
Brake System.....	See Section A, p. 2
Bumpers, Energy-Absorbing.....	See Section A, p. 2, 3
Frame.....	12
Shock Absorbers.....	See Section A, p. 4
Steering Column, Energy- Absorbing.....	See Section A, p. 2
Steering Column, Locking.....	See Section A, p. 1
Steering, Manual.....	13
Steering, Power.....	13
Suspension, Front.....	13
Suspension, Rear.....	13
Suspension Specifications.....	14
Solid State Ignition.....	See Section A, p. 5
Tires.....	See Section A, p. 4

Wheels..... See Section A, p. 2

COLOR AND TRIM.....26, 27

MARKET DATA.....3

OPTIONS

Complete Listing.....	22, 23
Anti-Theft Alarm System.....	19
Appearance Protection Group.....	20
Bumper Group, Deluxe.....	19
Convenience Group.....	20
Door Locks, Electric Power.....	18
Defroster, Electric Rear Window.....	18
Fender Skirts.....	20
Light Group.....	19
Metallic Glow Paint.....	20
Opera Windows.....	20
Radio, AM.....	20
Radio, AM/FM Stereo.....	20
Radio, AM/FM Stereo With Tape Player.....	20
SelectAire Air Conditioner.....	19
SelectAire Air Conditioner With Automatic Temperature Control.....	19
Speed Control, Fingertip.....	18
Steering Wheel, Leather-Wrapped.....	20
Steering Wheel, Tilt.....	18
Sunroof.....	21
Traction-Lok Differential.....	18
Trailer Towing Packages.....	21
Vinyl Roof.....	20
Vinyl Insert Bodyside Molding.....	19
Wheel Cover.....	21
Wheel Cover, Deluxe.....	21
Wheel Cover, Luxury.....	21
Wheel, Magnum 500 Steel.....	21

SPECIFICATIONS

Body Dimensions.....	25
Brake Specifications.....	24
Power Team Selections.....	24
Steering Specifications.....	24
Tire Availability, Standard.....	23
Tire Availability, Optional.....	23
Wheel Specifications.....	24

STANDARD EQUIPMENT.....11

STATION WAGON FEATURES.....10

TORINO 10 MODELS

TWO-DOOR FORMAL HARDTOPS (3)

	Sales Code No.	Body Code No.
Torino.....	25	65B
Gran Torino.....	30	65D
Gran Torino Brougham	32	65K



FOUR-DOOR PILLARED HARDTOPS (3)

	Sales Code No.	Body Code No.
Torino.....	27	53B
Gran Torino.....	31	53D
Gran Torino Brougham	33	53K



TWO-DOOR FORMAL HARDTOP— SPORT SERIES (1)

	Sales Code No.	Body Code No.
Gran Torino Sport.....	38	65R



STATION WAGONS (3)

	Sales Code No.	Body Code No.
Torino.....	40	71B
Gran Torino.....	42	71D
Gran Torino Squire.....	43	71K





TORINO

**Look closely—
at a really solid car.**

The closer you look, the more you appreciate the solid value beautiful Torino offers. Room for six adults with handling ease of a mid-size car. And a choice of 10 luxurious new models including three smart Station Wagons.

TORINO SERIES



MODELS

2-Door Hardtop—Formal Roof
4-Door Pillared Hardtop

SALES
NUMBER

25
27



MAJOR STANDARD FEATURES

EXTERIOR

- Attractive low-series, one-piece, corrosion-resistant plastic grille with wide eggcrate motif in bright and dark argent and center ornament.
- 114" wheelbase . . . 2-door models with 211.4" overall length and wide tread for sporty, "road-hugger" look.
- Long 118" wheelbase . . . 4-door models with 215.4" overall length for "big-car" look, roominess and ride.
- Torino ornament on fuel door cover.
- Distinctive, dual horizontal headlights.
- Energy-absorbing bumper system . . . 5 MPH front, 5 MPH rear, and 3 MPH corner impact.
- Recessed door handles with one-step keyless locking.
- 60° windshield and bright reveal moldings around windshield and rear window.
- Front and rear side marker lights.
- New taillight design with integral rear side marker light . . . backup light centered in taillight.
- Frameless, ventless curved side glass.
- Bright drip and window moldings.
- Bright "Ford" block letters on center of hood panel above grille and lower deck lid.
- Bright "Torino" block letters on front fenders.
- Bright stainless steel hubcaps.
- Hatch hood.
- Body/Frame construction.

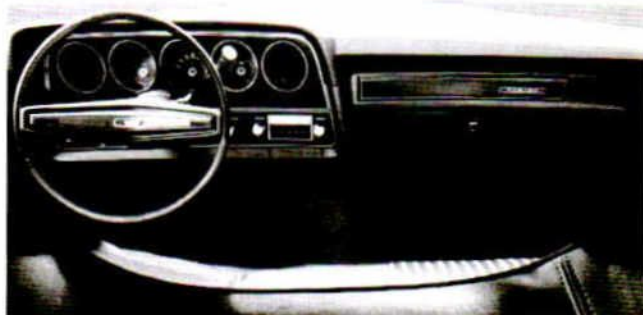
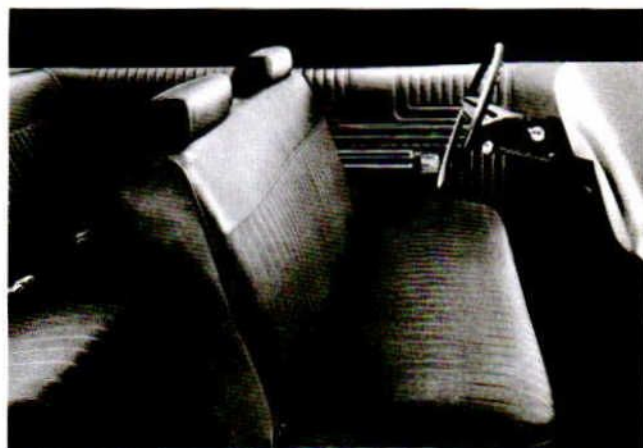

INTERIOR

- Comfortable front bench seats with adjustable head restraints and seat-back locks on folding seat-backs.
- Attractive, durable all-vinyl seat trim with all-vinyl color-keyed door trim panels.
- 12-oz. color-keyed loop-pile carpeting.
- Instrument panel with modern, easy-reading instruments . . . textured metal lower instrument panel color-keyed to interior.
- Two-spoke color-keyed energy-absorbing steering wheel.
- Glove box with twist lock.
- Turn signals with lane-changing feature.
- Dome light in center of roof.
- Day/Night rearview mirror, vinyl backed and framed.
- Illuminated wiper/washer controls.
- Energy-absorbing armrests.
- Sun visor safety padded, left and right.
- Suspended accelerator, clutch and brake pedals.
- Inside hood release.

FUNCTIONAL

- Dependable 302 CID 2V V-8 engine.
- Three-speed, fully synchronized, manual transmission with column shift.
- Manual front disc brakes.
- Heater and defroster with 3-speed blower . . . illuminated controls.
- "DirectAire" ventilation system in all models.
- Fixed rear side glass (2-door model).
- Energy-absorbing frame construction.
- Recessed windshield wipers, 2-speed electric with dual-stream washers . . . larger 80-oz. washer reservoir.
- G78 x 14 BSW belted bias ply tires.
- Convenient pin-and-slot bumper jack system.

See page C-11 for a complete list of standard equipment.

GRAN TORINO SERIES



MODELS

- 2-Door Hardtop—Formal Roof
- 4-Door Pillared Hardtop

SALES
NUMBER

30
31



MAJOR STANDARD FEATURES

EXTERIOR

In addition to or in place of features on the Torino Series:

- Long 213.6" overall length 2-door models . . . 217.6" on 4-door models.
- High series corrosion-resistant grille with bright and argent segmented design . . . bright leading edges framed with chrome-plated molding . . . bright molding around the grille.
- Gran Torino grille ornament.
- Bright "Ford" block letters over center of grille and lower deck lid.
- Bright headlamp doors.
- Bright wheelip moldings.
- Bright rocker panel and rear quarter extension moldings.
- Bright "Gran Torino" block letters on front fender.
- Gran Torino emblem, with surround wreath, on fuel door cover.
- Black paint-filled moldings on lower back panel.



INTERIOR

In addition to or in place of features on the Torino Series:

- Plush, deep-pleated cloth-and-vinyl seat trim.
- Rear armrests on 2-door models.
- Deluxe sound package.
- Luggage compartment mat.



FUNCTIONAL

The Gran Torino Series shares many features with the Torino Series. Mutual features include:

- Dependable 302 CID 2V V-8 engine.
- Three-speed, fully synchronized, manual transmission with column shift.
- Manual front disc brakes.
- Self-adjusting brakes.

- Heater and defroster with 3-speed blower . . . illuminated controls.
- "DirectAire" ventilation system in all models.
- G78 x 14 BSW belted bias ply tires.
- Convenient pin-and-slot bumper jack system.
- Recessed windshield wipers, 2-speed electric with dual-stream washers.

See page C-11 for a complete list of standard equipment.

GRAN TORINO BROUGHAM



MODELS

2-Door Hardtop—Formal Roof
4-Door Pillared Hardtop

SALES
NUMBER

MAJOR STANDARD FEATURES

32
33



EXTERIOR

The Gran Torino Brougham shares many features with the Gran Torino. Mutual features include:

- High series corrosion-resistant grille with bright and argent segmented design . . . bright leading edges with chrome-plated molding . . . bright molding around the grille.
- Bright headlamp doors.
- Bright wheelip moldings.
- Bright "Ford" letters over center of grille and right rear deck lid.
- Bright "Gran Torino" block letters on front fenders.
- Bright rocker panel and rear quarter extension moldings . . . front fender extension moldings added for Brougham models.
- Black paint-filled moldings lower back panel.
- Concealed windshield wipers.

Additional features include:

- Brougham stand-up hood ornament.
- Opera window . . . distinctive trapezoid design (2-door models).
- "Brougham" identification on "C" pillars (on opera window . . . 2-door models).
- Red reflector lower back panel insert with Torino script on die-cast bar.
- Wide bright belt moldings (2-door models).
- Full-vinyl roof in: White, Blue, Green, Brown, Tan and Gold.
- Wide vinyl insert bodyside molding color-keyed to vinyl roof.
- Deluxe wheel covers.

INTERIOR

In addition to or in place of features on the Gran Torino:

- Split bench front seat.
- Luxury Westminster cloth seat trim or no-cost optional super-soft all-vinyl trim.
- Dual fold-down center armrests.
- Luxury Westminster cloth door trim panels.
- Simulated woodgrain appliqué on instrument panel.
- Cut-pile carpeting.
- Electric clock.
- Bright rimmed pedal pads.
- Deluxe 2-spoke steering wheel.
- Dual note horn.
- Soft fiber carpeting and side lining boards in luggage compartment.
- Color-keyed deluxe seat and shoulder belts.



FUNCTIONAL

The Gran Torino Brougham shares many features with the Gran Torino. Mutual features include:

- 302 CID 2V V-8 engine.
- Three-speed, fully synchronized manual transmission.
- Manual front disc brakes.
- Self-adjusting brakes.
- Heater and defroster with 3-speed blower . . . illuminated controls.
- "DirectAire" ventilation system.
- Recessed windshield wipers, 2-speed electric with dual-stream washers.

Additional features include:

- Deluxe sound package.
 - HR78 steel-belted WSW tires.
- See page C-11 for a complete list of standard equipment.

GRAN TORINO SPORT



MODEL

2-Door Hardtop—Formal Roof

SALES
NUMBER

38

MAJOR STANDARD FEATURES

EXTERIOR

In addition to or in place of features on the Gran Torino Series:

- "Sport" grille ornament.
- Dual fender peak paint stripes.
- "Sport" script and crest on "C" pillar.
- Dual outside color-keyed left- and right-hand remote-control mirrors.
- Unique "Sport" ornament on fuel door cover.
- New "Turbine" wheel covers.
- Front fender lower molding.
- Wide bright belt moldings.



INTERIOR

In addition to or in place of features on the Gran Torino Series:

- Performance cluster consisting of: tachometer, trip odometer, engine gauges (Oil, Ampere, Temp., Fuel) and electric clock.
- Flight bench seat with fold-down center armrest (bucket seats in lieu of flight bench . . . no charge RPO).
- Super-soft vinyl seat trim.
- Cut-pile carpeting (25 oz.).
- Super-soft vinyl door trim.
- "Engine turned" black appliqué on performance cluster and right-hand panel.
- Deluxe 2-spoke steering wheel with simulated wood-tone appliqué.
- Bright rimmed pedal pads.
- Color-keyed deluxe seat and shoulder belts.



FUNCTIONAL

The Gran Torino Sport shares many features with the Gran Torino. Mutual features include:

- 302 CID 2V V-8 engine.
- Three-speed, fully synchronized manual transmission.
- Manual front disc brakes.
- Self-adjusting brakes.
- Heater and defroster with 3-speed blower . . . illuminated controls.
- "DirectAire" ventilation system.
- Concealed windshield wipers, 2-speed electric with dual-stream washers.
- Deluxe sound package.

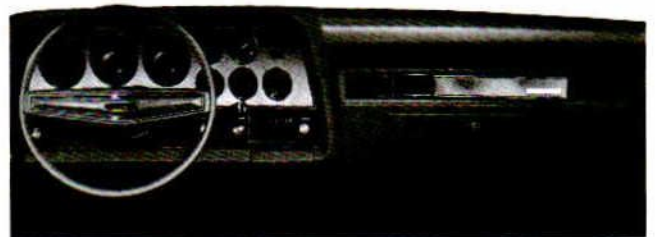

Additional features include:

- HR78 steel-belted WSW tires.

See page C-11 for a complete list of standard equipment.

TORINO AND GRAN TORINO STATION WAGONS

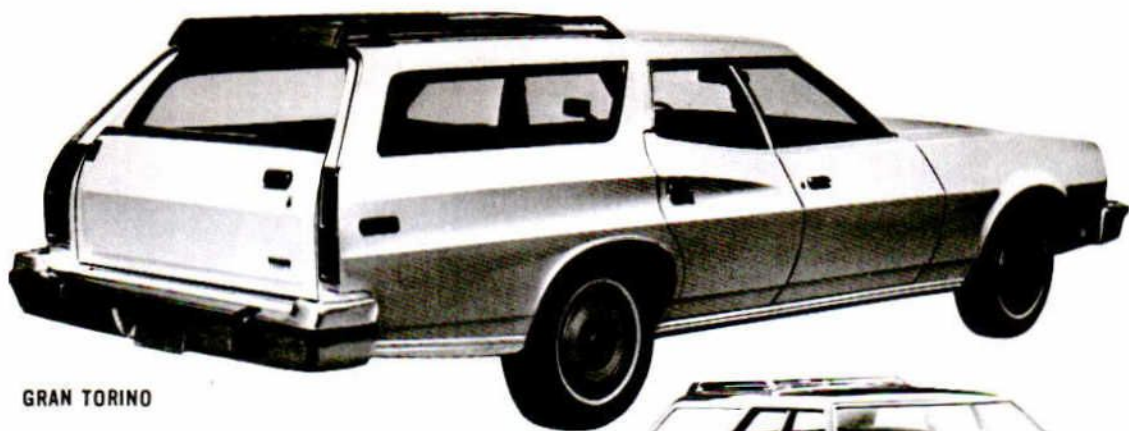

GRAN TORINO

MODELS

Torino 4-Door
Gran Torino 4-Door

SALES
NUMBER

40
42



TORINO

MAJOR STANDARD FEATURES

TORINO WAGON

In addition to or in place of features on the Torino 4-Door Pillared Hardtop:

EXTERIOR

- Long 219.1" overall length.
- Bright drip moldings.
- Bright quarter window and tailgate window moldings.
- Bright "Torino" block letters on lower right corner of tailgate.
- Vertical taillamp design with integral backup lights.
- Bright "Ford" block letters on black tailgate molding.
- Rear bumper guards . . . vinyl inserts.

INTERIOR

- Wide 48.2" loadspace between wheelhousings.
- Fold-down second seat for a long load floor length of 87.5" with tailgate up . . . 109.5" with tailgate down . . . 84.9 cubic feet cargo volume.
- Load floor and back of second seat are painted with long-wearing vinyl-impregnated paint, color-keyed to the interior.
- Lockable storage compartment under load floor adds 8.1 cubic feet of storage space.

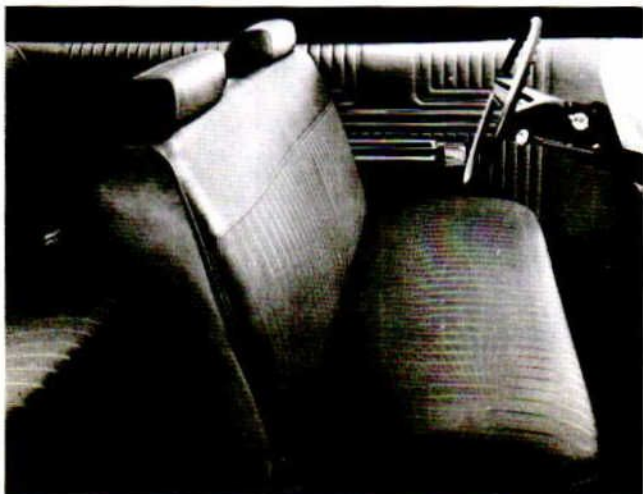

FUNCTIONAL

- 302 CID 2V V-8 engine.
- SelectShift Cruise-O-Matic transmission.
- Three-way "Magic Doorgate"—opens horizontally like a door with window up or down . . . or swings down like an ordinary tailgate.
- Manual roll-down tailgate window.
- Power front disc brakes standard.
- H78 x 14 BSW belted bias ply tires.

See page C-11 for a complete list of standard equipment.

GRAN TORINO WAGON

In addition to or in place of features on the Torino Wagon, the Gran Torino offers:

EXTERIOR

- Long 221.3" overall length.
- High series corrosion-resistant grille with bright and argent segmented design . . . bright leading edges framed with bright chrome-plated molding.
- Gran Torino grille ornament.
- Bright headlamp doors.
- Bright wheelip moldings.
- Bright rocker panel and rear fender extension moldings.
- Bright two-piece "Gran Torino" block letters on front quarter panel.

INTERIOR

- Plush, deep-pleated vinyl seat trim.

FUNCTIONAL

Additional sound-deadening and insulating material. (See page C-15).

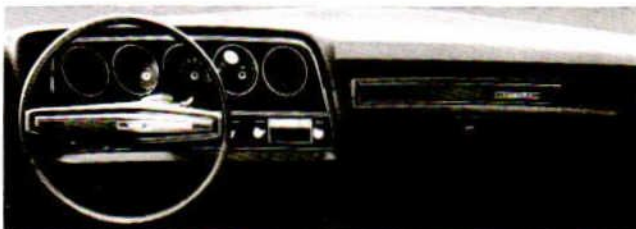

GRAN TORINO SQUIRE STATION WAGON



SALES
NUMBER

43

MODEL

Gran Torino Squire 4-Door

MAJOR STANDARD FEATURES

GRAN TORINO SQUIRE WAGON

In addition to or in place of features on the Gran Torino Wagon, the Gran Torino Squire offers:

EXTERIOR

- "Color-Match" simulated woodgrain paneling appliqué on bodyside and tailgate.
- Simulated limed-oak woodgrain vinyl-clad aluminum side rails frame "Color-Match" paneling.
- Bright "Squire" script on front quarter panels.
- Full wheel covers.

INTERIOR

- Luxurious vinyl seat trim . . . color coordinated door trim features with simulated woodgrain appliqué.
- Deluxe 2-spoke steering wheel with woodtone appliqué.
- Simulated woodgrain appliqué on instrument panel.
- Bright accented pedal pads.
- Color-keyed deluxe seat and shoulder belts.

FUNCTIONAL

The Gran Torino Squire shares many features with the Gran Torino Wagon. Mutual features include:

- Economical power from 302 CID engine.
- SelectShift Cruise-O-Matic transmission.
- Power front disc brakes.

Additional features include:

- Power tailgate window.
- HR78 steel-belted WSW tires.
- Dual note horn.

See page C-11 for a complete list of standard equipment.

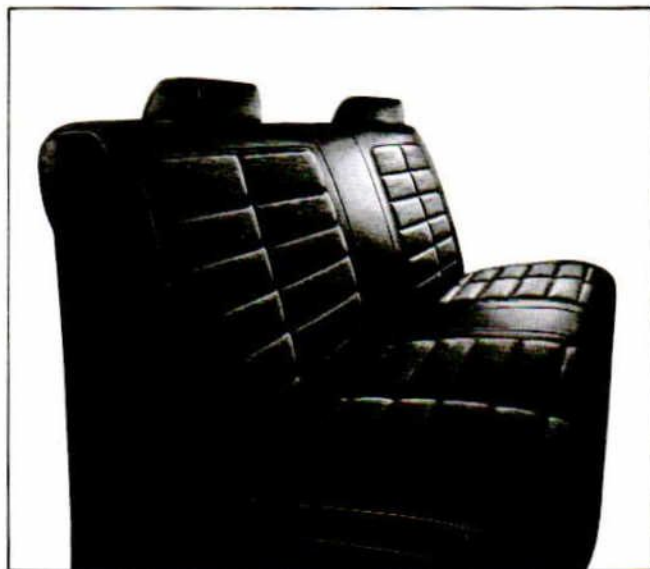
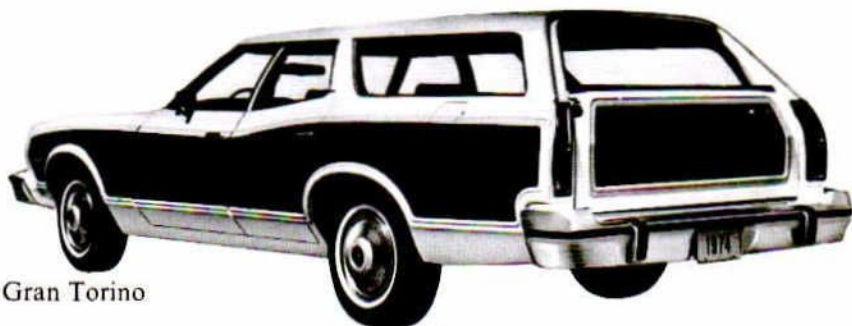

TORINO STATION WAGONS

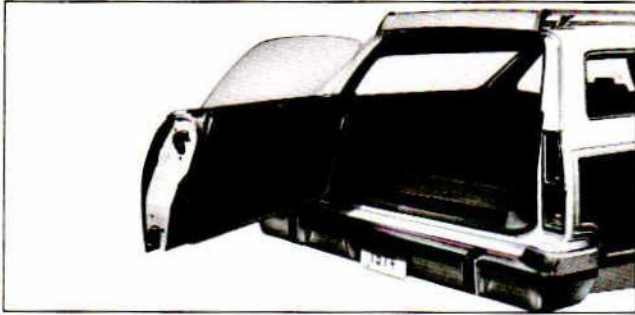

THREE-WAY MAGIC DOOR GATE

Torino wagons feature the Three-Way Magic Door Gate that folds down like a tailgate or swings open like a door. When used as a door, the glass can be up or down. A safety interlock system requires that the glass be lowered before the door can be used as a tailgate and a safety lock button prevents accidental opening of the door. When the button is depressed, the door can be opened only with the key or the optional electric power door locks which include the tailgate lock. All locks are controlled by the lock buttons on the driver's and front passenger's door. A power-operated tailgate window is standard on the Gran Torino Squire and optional on the Torino and Gran Torino wagons.

On all wagons, one easy motion folds the second seat into the floor to provide an 87.5-inch long floor area with the tailgate up.

All load floor panels, including the second seat back, are coated with a special vinyl base paint that resists scuffing and scratching.

An optional rear-facing third seat provides seating for two additional passengers.

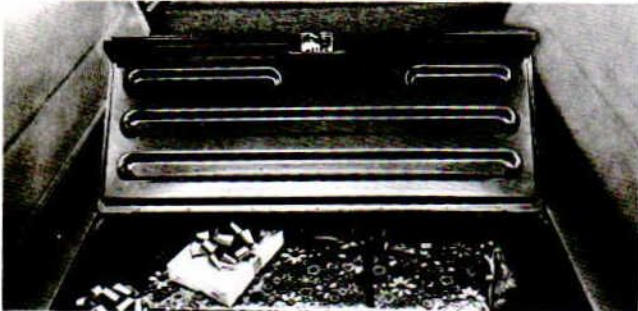

UNDER-FLOOR STORAGE COMPARTMENT

All Torino wagons include an extra storage compartment hidden beneath the load floor. This handy compartment is lockable and provides an additional 8.1 cubic feet (5.9 with third seat) of storage space.

POWER FRONT DISC BRAKES

Power brakes are standard on all the Torino station wagon series. Front disc brakes and flared drum rear brakes are proportioned in their application for easy braking and safe, carefree driving. See Section A, page 2 for additional disc brake information.

SELECTSHIFT CRUISE-O-MATIC TRANSMISSION

For 1974, Torino wagons feature Ford's famous SelectShift Cruise-O-Matic as standard equipment. This versatile transmission features a choice of automatic or three-speed manual . . . with isolated second gear for use on ice or snow. (See Power Teams section for additional information.)

SQUIRE BROUGHAM OPTION

New for 1974, the Squire Brougham Option adds the touch of luxury to the Gran Torino Squire. Included in this new, luxury option are: a split bench seat with dual fold-down center armrests, super-soft vinyl inserts and door trim, plush 25-oz. cut-pile carpeting in the passenger compartment, and cut-pile carpet on the load floor, and an electric clock. The generous exterior appointments include: deluxe wheel covers and stand-up "Brougham" hood ornament.

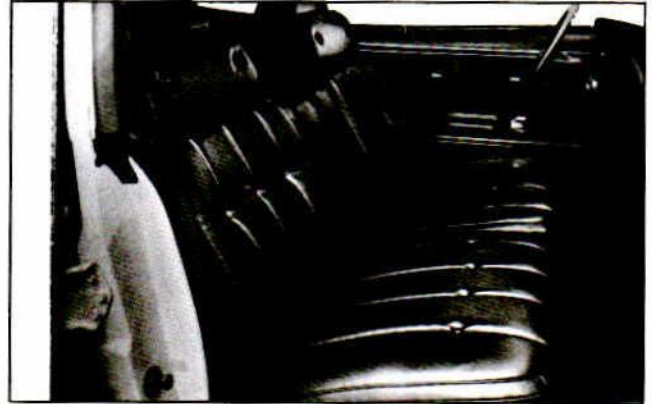

DELUXE LUGGAGE RACK OPTION

Torino's deluxe luggage rack features wide, strong, steel side rails highlighted by a glass bead texture finish. The rear crossbar, which is fully adjustable, is attached by brackets to slots in the side rails; it can be moved forward and locked in position when less than full loads are carried. The deluxe rack includes a built-in air deflector with glass bead finish which directs an air stream over the rear window to help prevent the accumulation of dirt deposits.

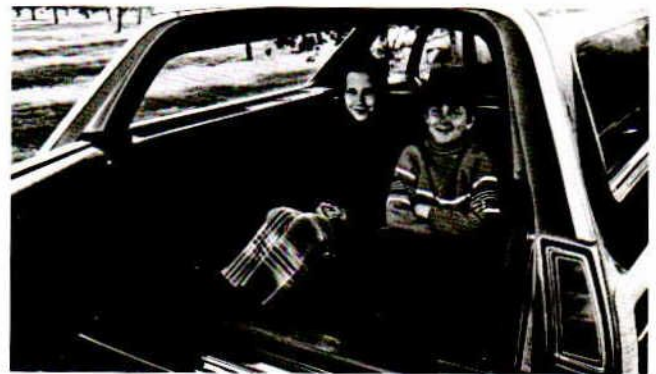

REAR FACING THIRD SEAT

The rear-facing third seat provides additional passenger room in the Gran Torino and Squire Wagons. When raised, the seat-back locks into an upright position. When closed, the panel may be locked to provide lockable storage space.

ELECTRIC REAR WINDOW DEFROSTER

This convenience station wagon option is ideal for cold weather driving since it is designed to remove small accumulations of ice and snow in minutes. Similar to the rear window electric defroster on other Torino models, it consists of high-resistance electric elements which are silk-screened on the inside of the window. A switch for operating the unit is integrated with the heater controls and a reminder light indicates when the unit is on. A heavy-duty alternator is included with this option.

TORINO STANDARD EQUIPMENT

In addition to the standard features listed, Torino includes as standard equipment the many Ford Lifeguard Design Safety Features listed on page 1.							
EXTERIOR	Torino	Gran Torino	Gran Torino Brougham	Gran Torino Sport	Torino Wagon	Gran Torino Wagon	Gran Torino Squire Wagon
BUMPERS: Energy-absorbing, front and rear—5 MPH	X	X	X	X	X	X	X
CONCEALED WINDSHIELD WIPERS	X	X	X	X	X	X	X
HOOD: Counterbalanced, front opening, hatch panel	X	X	X	X	X	X	X
LIGHTS: Backup, parking, dual headlights, front and rear side marker	X	X	X	X	X	X	X
TAILLIGHTS: Horizontal sec., integral side marker lights, backups center	X	X	X	X	—	—	—
Vertical with backups in lower section	—	—	—	—	X	X	X
MOLDINGS: Bright drip moldings	X	X	X	X	X	X	X
Wheellip moldings	—	X	X	X	—	X	—
Door belt moldings	X	X	X	X	X	X	X
Rear window bright reveal moldings	X	X	X	X	X	X	X
Windshield reveal moldings	X	X	X	X	X	X	X
Rocker panel and fender extension molding	—	X	X	X	—	X	—
Vinyl insert bodyside molding, color-keyed	—	—	X	—	—	—	—
Black tailgate molding	—	—	—	—	X	X	X
MIRROR: outside (left-hand)	X	X	X	—	X	X	X
Outside, color-keyed, left and right-hand remote-control	—	—	—	X	—	—	—
ORNAMENTATION: "Ford" block letters front over center of grille	X	X	X	X	X	X	X
"TORINO" block letters on front fenders	X	—	—	—	X	—	—
"GRAN TORINO" block letters on front fenders	—	X	X	X	—	X	X
"BROUGHAM" identification on "C" pillar (opera window 2-door)	—	—	X	—	—	—	—
"SPORT" script and emblem on "C" pillar	—	—	—	X	—	—	—
"TORINO" block letters lower right tailgate	—	—	—	—	X	X	X
"FORD" block letters rear deck lid	X	X	X	X	—	—	—
Fuel door cover ornament	X	X	—	X	—	—	—
Lower back panel red reflector insert with "TORINO" script	—	—	X	—	—	—	—
"SQUIRE" script on front quarter panels	—	—	—	—	—	—	X
"BROUGHAM" stand-up hood ornament	—	—	X	—	—	—	X(a)
GRILLE: Plastic, argent painted, bright edges	X	—	—	—	X	—	—
Bright and argent high-series segmented design	—	X	X	X	—	X	X
Identification ornament on grille	X	X	—	X	X	X	X
HUB CAPS: stainless steel	X	X	—	—	X	X	—
TURBINE WHEEL COVERS	—	—	—	X	—	—	—
WHEEL COVERS: full	—	—	—	—	—	—	X
WHEEL COVERS DELUXE	—	—	X	—	—	—	X(a)
VINYL ROOF	—	—	X	—	—	—	—
OPERA WINDOW (2-door)	—	—	X	—	—	—	—
PAINT STRIPES: dual fender peak	—	—	—	X	—	—	—
SIMULATED WOODGRAIN TRIM ON TAILGATE AND BODYSIDES	—	—	—	—	—	—	X
VENTLESS DOOR GLASS	X	X	X	X	X	X	X

INTERIOR

ARMRESTS: Energy-absorbing, front and rear on 4-door models	X	X	X	X	X	X	X
Fold-down center armrest	—	—	—	X	—	—	—
Dual fold-down center armrests	—	—	X	—	—	—	X(a)
ASHTRAY: front (not lighted)	X	X	X	X	X	X	X
CIGARETTE LIGHTER: In instrument panel	X	X	X	X	X	X	X
CLOCK, ELECTRIC	—	—	X	X	—	—	X(a)
COURTESY LIGHTS: Center of roof	X	X	X	X	X	X	X
DOOR HANDLES: Inside, Safety design	X	X	X	X	X	X	X
Outside, Recessed	X	X	X	X	X	X	X
DOOR LATCHES: Safety-yoke type	X	X	X	X	X	X	X
FLIGHT BENCH FRONT SEAT:	—	—	—	X	—	—	—
Split bench front seat	—	—	X	—	—	—	X(a)
FLOOR COVERING:							
Carpet, color-keyed loop-pile	X	X	—	—	X	X	X
Carpet, cut-pile color-keyed	—	—	X	X	—	—	X(a)
GLOVE BOX WITH TWIST LOCK	X	X	X	X	X	X	X
HEAD RESTRAINTS: Front adjustable	X	X	X	X	X	X	X
INSIDE HOOD RELEASE	X	X	X	X	X	X	X
INSTRUMENT PANEL: Energy-absorbing printed instrument cluster circuitry	X	X	X	X	X	X	X
Woodgrain Accents	—	—	X	—	—	—	X
MIRROR, INSIDE DAY/NITE REARVIEW	X	X	X	X	X	X	X
PEDAL PADS, BRIGHT RIMMED	—	—	X	X	—	—	X
PERFORMANCE CLUSTER: tachometer, trip odometer (Fuel, Amp., Temp., Oil) camera black applique	—	—	—	X	—	—	—
SCUFF PLATES: aluminum	X	X	X	X	X	X	X
SEAT BACK LOCKS: (all folding seats)	X	X	X	X	X(b)	X(b)	X(b)
LAP BELTS: Front (center passenger) & rear	X	X	X	X	X	X	X
RESTRAINT SYSTEM: Driver—front outboard passenger with integral lap and shoulder belts	X	X	X	X	X	X	X
COLOR-KEYED SEAT AND SHOULDER BELTS	—	—	X	X	—	—	X
STEERING WHEEL: 2-spoke energy-absorbing, oval design	X	X	—	X	X	X	X
Simulated woodgrain 2-spoke energy-absorbing	—	—	X	X	—	—	X
STORAGE COMPARTMENT: Below floor with lock	—	—	—	—	X	X	X
SUN VISORS, padded	X	X	X	X	X	X	X
SUSPENDED PEDALS: Clutch and brake	X	X	X	X	—	—	—
TURN SIGNALS: Lane-change feature	X	X	X	X	X	X	X

(a) Squire Brougham Option (b) Rear folding seats on station wagons

continued on next page

TORINO STANDARD EQUIPMENT (Cont'd)

In addition to the standard features listed, Torino includes as standard equipment the many Ford Lifeguard Design Safety Features listed on page 1.							
FUNCTIONAL	Torino	Gran Torino	Gran Torino Brougham	Gran Torino Sport	Torino Wagon	Gran Torino Wagon	Gran Torino Squire Wagon
BRAKES: Self-adjusting	X	X	X	X	X	X	X
Foot-applied emergency brake hand-released	X	X	X	X	X	X	X
Manual front disc brakes	X	X	X	X	—	—	—
Power front disc brakes	—	—	—	—	X	X	X
ENGINE: 302 CID 2V V-8	X	X	X	X	X	X	X
DIRECTAIRE VENTILATION	X	X	X	X	X	X	X
HEATER: blend-air type, 3-speed blower	X	X	X	X	X	X	X
KEYS: reversible type and keyless door locking	X	X	X	X	X	X	X
MUFFLER: aluminized & stainless components	X	X	X	X	X	X	X
TAILGATE: Three-way Magic Doorgate	—	—	—	—	X	X	X
TAILGATE POWER WINDOW	—	—	—	—	—	—	X
TRANSMISSION: SelectShift Cruise-O-Matic	—	—	—	—	X	X	X
3-speed manual	X	X	X	X	—	—	—
WINDSHIELD WIPERS: two-speed electric with dual stream washers	X	X	X	X	X	X	X
DUAL NOTE HORN	—	—	X	—	—	—	X
IGNITION INTER-LOCK: Incorporated in 3-point restraint system	X	X	X	X	X	X	X

TORINO FEATURES

CHASSIS FEATURES

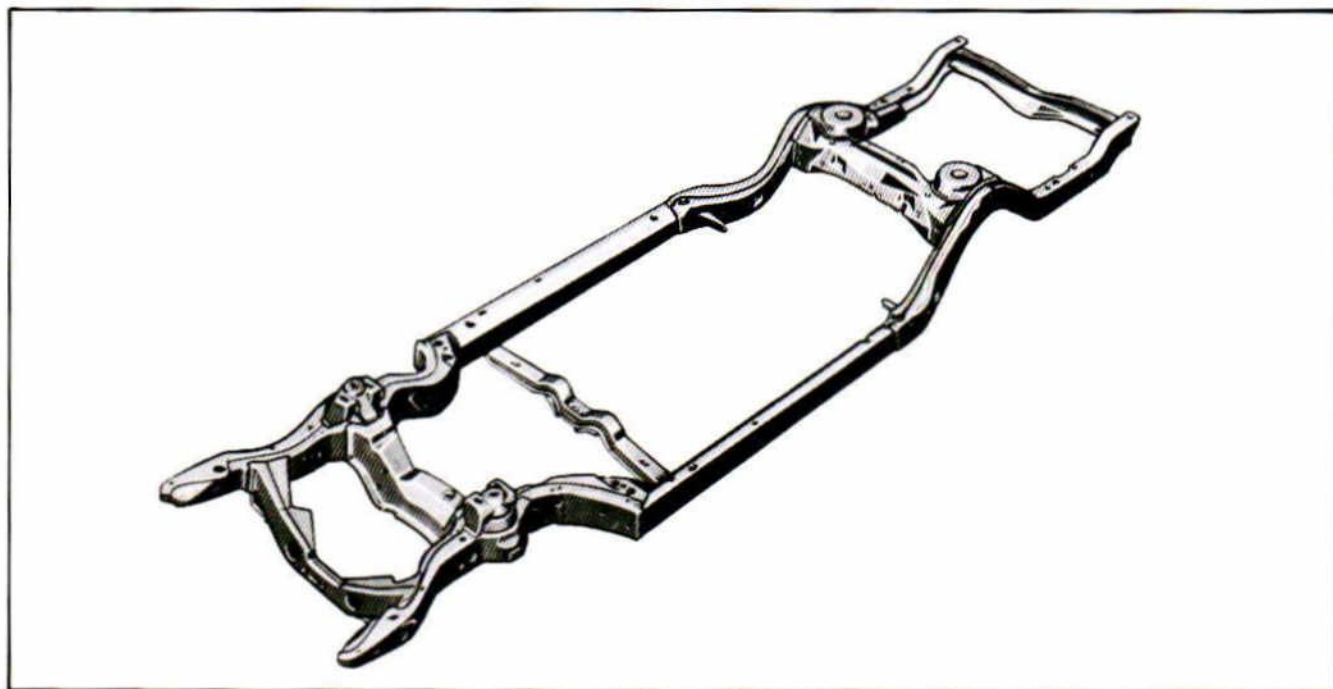

FRAME

The Torino torque box frame is designed to substantially reduce road shocks, thereby providing a smooth, comfortable ride.

Major improved damageability features of the frame are the reinforced front frame rails and energy-absorbing mechanism of the bumper system.

Features of the design are:

Reinforced outer frame bracing from the front spring pockets to localize the front rail collapse forward of the steering gear and front body mounts.

Reinforced front torque boxes to further localize energy absorption.

The front and rear energy-absorbing bumpers are attached to the frame through mounting pockets, allowing the bumper, impact beam and absorbers to work as a system. This system is capable of sustaining 5 mph front and rear barrier impacts and 3 mph corner impacts without damage to safety-related components. See Section A, pages 2 and 3 for additional information on energy-absorbing bumper system.

A rugged number four crossmember contains the spring pocket for the coil springs, the mounting holes for the shock absorbers and mounting anchors for the upper two trailing arms.

A special feature of the frame is the reinforcing of the side rail at the torque box area to anchor the lower trailing arms. The frame construction lends itself to the easy application of trailer hitches.

TORINO FEATURES

MANUAL STEERING

Torino's steering system is a parallelogram linkage-type with a cross-link and idler arm. This system offers positive vehicle control under all driving conditions. Features of the steering system include:

The cross-link bar is positioned to improve directional stability.

The steering shaft control assembly is driven by recirculating ball bearings in a closed guide tube that helps reduce friction.

The "Magic Circle" steering gear is filled with a lifetime lubricant which, under normal circumstances, never needs changing.

(See page C-23 for steering specifications.)

POWER STEERING

Ford's power steering with power applied directly to the "Magic Circle" gear is optional in all Torinos. This is the same system used in the Thunderbird car line.

Ford Motor Company's "Better Idea" power steering pump with "fluidic control" is also a feature of the Torino power steering system. Other features of this power steering system include:

An integral control valve and steering gear design provide instant response to wheel movement. A built-in low restriction control valve allows the wheels to quickly return to center position after making a turn.

A torsion bar element in the steering shaft provides driver "feel" of the road.

A 21.8 to 1 overall steering ratio provides responsive handling with light steering effort.

Lock-to-Lock steering of 3.50 turns . . . approximately 30% faster than manual steering.

(See page C-23 for steering specifications.)

FRONT SUSPENSION

For 1974 Torino's suspension continues to be a short and long arm type with the coil springs mounted on the lower arm. This clears the engine compartment of space-robbing spring towers. The "36,000-mile lub." ball joints are continued. Springs and shock absorbers are tuned to match the weight/

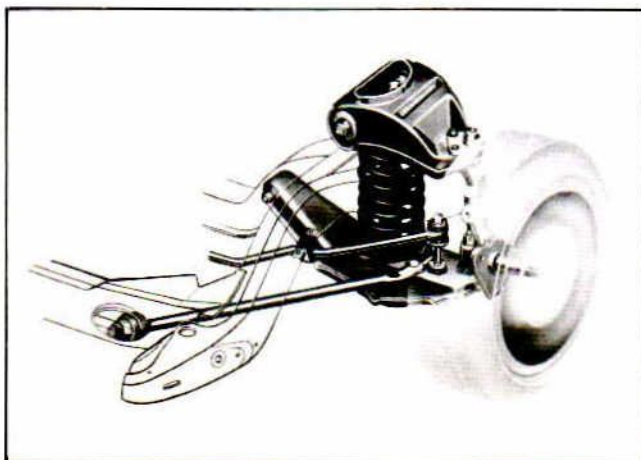

ride requirements of each application depending on the car model, engine selection and optional equipment. Front suspension features include:

Left and right axial struts stabilize the lower arms and are attached to the frame through rubber bushings to eliminate metal-to-metal contact. The compliant rubber bushings reduce the amount of road disturbance transmitted to the passenger area and allow the wheels to move slightly toward the rear when hitting a bump. This controlled rear movement soaks up part of the initial road shock before it reaches the passenger area.

A link-type, rubber-bushed stabilizer bar connects the right- and left-hand lower suspension arms to help prevent excessive lean when cornering.

REAR SUSPENSION

Torino uses a four-link "Stabil" rear suspension system which improves stability of the car in either loaded or unloaded conditions. The coil springs, as in the front suspension, help provide an exceptionally smooth ride. Features of the system include:

Four longitudinal arms control the position of the rear axle assembly and absorb braking and accelerating forces.

The lateral location of the axle is maintained due to the arrangement of the arms. The lower arms are splayed inward from their attachment and the short upper arms are splayed outward placing the assembly under tension laterally. This arrangement gives the car strong directional stability and resistance to side-to-side body shake on rough roads.

Coil springs ride in deep rubber-insulated caps in the frame and are seated on the axle.

The arrangement of the control arms tends to stabilize the vehicle in roll.

Shock absorbers are mounted at an angle to help provide a controlled ride.

An optional "handling suspension" is available. See options, page C-22.

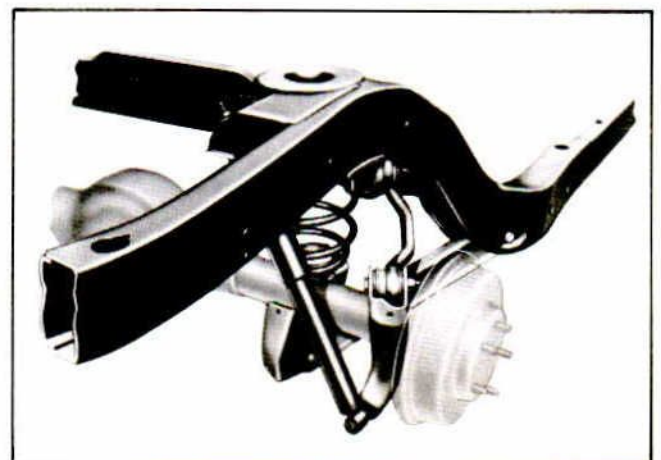

TORINO FEATURES

TORINO SUSPENSION SPECIFICATIONS

FRONT

Type	Independent with Ball Joints and Drag Struts
Springs	Coil, Rubber-Insulated
Shock Absorbers	Direct, Double-Acting Hydraulic
Stabilizer	Link-Type, Rubber-Bushed
Wheel Bearings	Taper Roller

REAR

Type	Four Trailing Control Arms
Springs	Coil, Rubber-Insulated
Shock Absorbers	Direct, Double-Acting Hydraulic

FRONT DISC/REAR DRUM BRAKES

Front disc brakes and rear drum brakes are standard on all Torino models. All station wagons feature power front disc brakes while the other models are manually operated. See page A-2 for additional description of disc brakes. Rear brake drums have been enlarged. All sedans, excluding station wagons, have 10 x 2½-inch rear brakes, while on station wagons, the rear brake size is 11 x 2¼-inch.

Torino's rear brakes incorporate self-adjusters. Self-adjustment is accomplished, if needed, when the brake is applied when the car is moving in reverse. Disc brake pad adjustment is maintained by the piston "O"-ring.

Torino's parking brake is mechanically applied by a convenient foot pedal and is released by a handle below the instrument panel.

BODY FEATURES

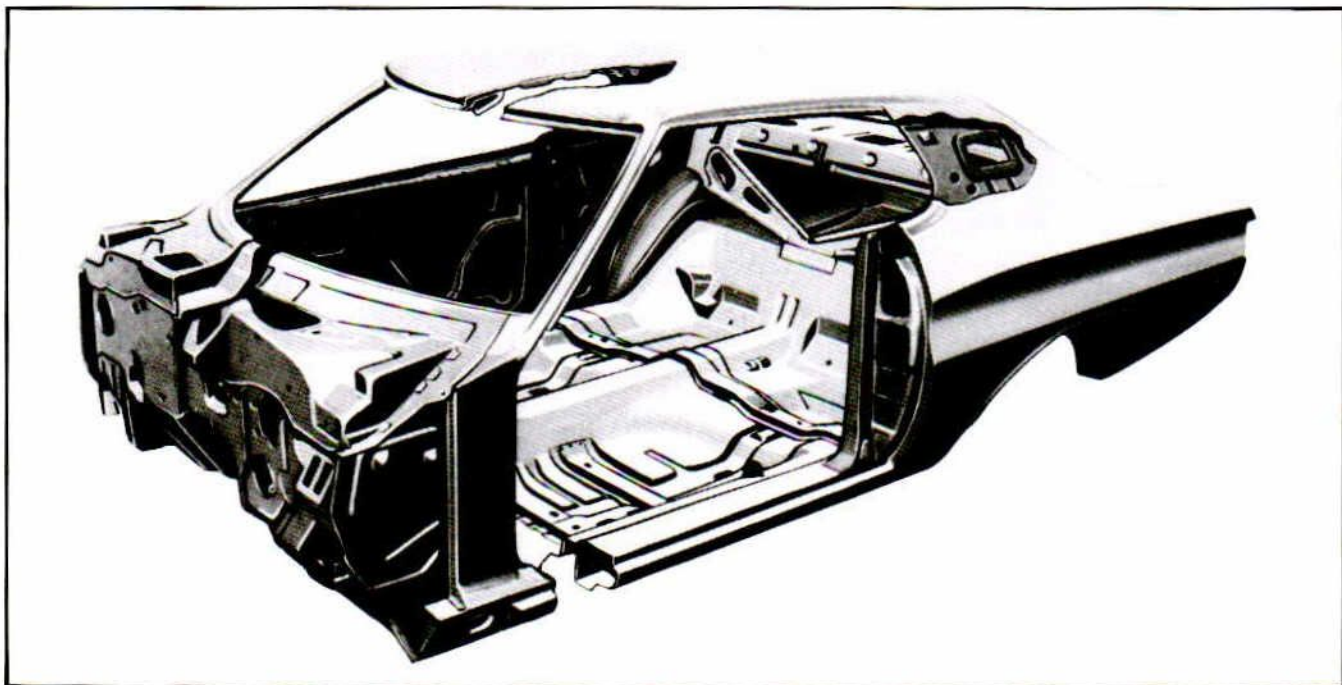

BODY CONSTRUCTION

The 1974 Torino bodies and the torque box frames are designed to work together to reduce road shock, noise and vibration, and the amount being transmitted to the passenger compartment. Features of the Torino body construction are:

A rigid body construction coupled with the compliant mounting to the torque box frame results in effective insulation of the passengers from noise, vibration and harshness.

The four-door Pillared Hardtop sedan has the appearance of a conventional pillarless construction, but additional roll-over strength has been added by sturdy thin body pillars.

Heavy sheet metal crossmembers in front seat and rear sill areas and stamped in stiffeners add strength to the floor panel.

A reinforced, double-panel construction rocker panel which is further strengthened by a U-channel section acts as a secondary frame support to the body.

Cowl ventilation air inlets at the top sides—directly below the windshield—permit structural continuity to be built into the cowl top and down the side pillars. All center pillars are manufactured from heavy gauge steel.

Additional body reinforcements in station wagon bodies provide added rigidity.

RUST PREVENTION

All vital underbody parts of the Torinos have been specially processed for resistance to the corrosive action of mud, water and road salt. Interior surfaces of the door panel, wheel splash areas and fenders have been coated with a zinc-rich primer. Rocker panels are made of zinc-clad steel and have one-way drain valves to prohibit moisture accumulation. Separate front wheelhouse panels help protect the fender areas. Exterior trim moldings are made of corrosion-resistant metal.

TORINO FEATURES

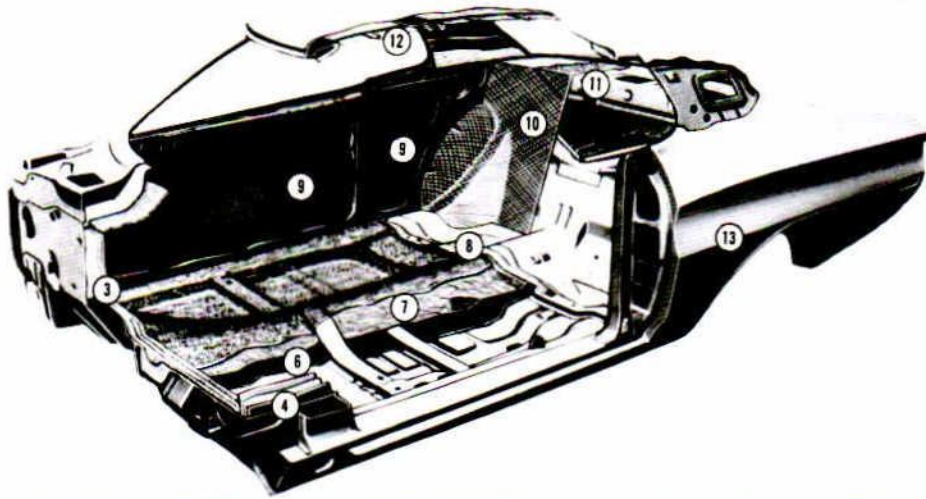

BODY INSULATION

The insulation and soundproofing package of the 1974 Torino provides an effective sound barrier to reduce road and engine noise.

- (1) The hood has mastic adhesive spotted between the inner and outer panel construction. Gran Torino, Gran Torino Brougham and Squire models have a one-inch fiberglass pad on the underside of the hood.
- (2) Front fenders have a sound-deadening coating sprayed on inner housings, including fender openings. Side seals have been added between the front fender inner reinforcement and the cowl sides.
- (3) The dash absorber construction on the Torino consists of a 1" thick fiber pad covered with a polyethylene skin. On the Gran Torino, Brougham and Squire, the dash absorber construction consists of a 1/2" thick fiber pad, a one-pound mastic barrier and a 1/2" thick fiber pad covered with a polyethylene skin.
- (4) Cowl side panels consist of a one-pound mastic sheet and a 1/4" fiber pad with crepe side cemented to sheet metal on Gran Torino, Brougham and Squire models. Cowl top is insulated with a 3/4" fiber pad.
- (5) The cowl top panel on the Gran Torino, Brougham and Squire models has a 1/2" fiber pad.
- (6) The front floor area on all Gran Torinos, Gran Torino Broughams and Gran Torino Squires has two layers of one-pound mastic sandwiching a layer of 28-gram fiber pad. A thick jute pad is also bonded to the floor covering. All other models have a layer of one-pound mastic plus the jute pad.
- (7) The insulation used on the rear floor is the same as that used on the front floor.
- (8) Under the rear seat is one-pound mastic sound-deadener on Gran Torinos, Gran Torino Broughams and Gran Torino Squire models.
- (9) Door and quarter panels have sprayed-on sound-deadener on the inner surface of the outer panels.
- (10) All two-door and four-door Hardtops use a two-ply felt pad back of the rear seat.
- (11) The package tray is insulated with a foam absorber.
- (12) Roof panels and rear pillars are insulated with 3/8" fiber pads. Rear pillar insulation consists of a 3/16" fiber pad, a chip board barrier and another 3/16" fiber pad covered with a polyethylene skin.
- (13) Rear wheelhouse splash areas are sprayed with sound-deadener coating.

Station Wagons also have insulation over the quarter wheelhouses, rear floor over axle, rear floor sides and deep well.

BODY SEALING MATERIAL

Following are some of the joint sealers and special anti-squeak sealing devices used in the Torino to help assure a comfortable, quiet ride.

Special plastic sealing material applied to exposed spot-welded panel seams and joints.

Vinyl-plastic sealer used at the drip rails and rear deck trough.

Windshields are sealed with butyl tape.

A special non-drying plastic seal is used in conjunction with the weatherstrip on all backlites.

Special pads, grommets, seals and plug buttons guard against water, dust and drafts.

Heat-curing sealer applied to all other panel seams and joints.

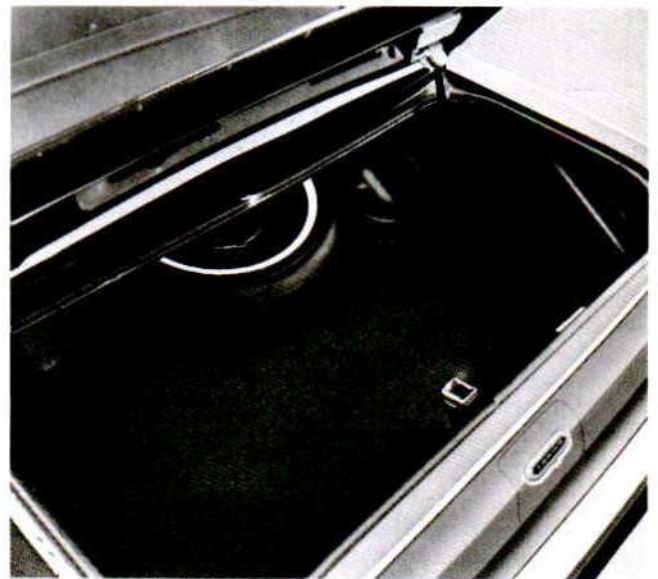

LUGGAGE COMPARTMENT

The usable luggage capacity in Torino Pillared Hardtops and two-door Hardtops is 16.5 cubic feet. Built-in torsion bars in the trunk lid hinges assist in raising the lid and in holding it open. Compression-type, neoprene rubber weatherstripping provides protection against dirt and moisture. A luggage compartment light is available as part of the optional Light Group.

TORINO FEATURES



CONCEALED WINDSHIELD WIPERS

Two-speed electric windshield wipers are standard on all Torinos. Concealed wipers, standard on all Torino models, are designed to "park" in a recessed area below the cowl.

The windshield glass extends into the recessed area so that the wiper blades are in constant contact with the glass, even in their concealed position. This "constant contact" feature helps to increase wiper blade life.

WINDOWS

All models of the Torino line feature modern, ventless side glass.

All windows, except windshields, are high-strength, impact-resistant, heat-tempered glass. The "thin" windshields are 7/32-inch thick with .030-inch thick vinyl sandwiched between the glass and heat-laminated together.

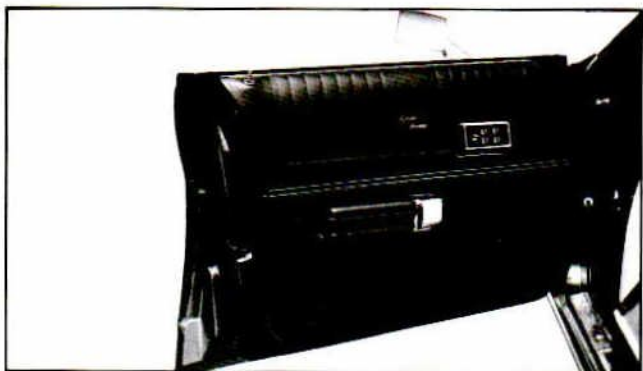

DOORS

Torino doors are formed into a sturdy box unit by using a double-panel welded construction. Bronze-bushed hinges are used for long wear and easy opening and closing. The lower hinges incorporate assist springs to aid in opening the door and to retard slamming when closing. All front doors incorporate check straps to provide an intermediate door check position to aid entry and exit when the car is parked in close quarters.

Bear-hug door latches increase rattle resistance and provide easy opening and secure closing operation. They also help protect against accidental opening on impact. All side doors also feature a steel "Guard Rail." See Side Impact Protection System, page A-6.

DOOR HANDLES AND ARMRESTS

Torino's exterior handles are pull-out type, recessed in the door surface. An unframed depression in the door panel provides finger room.

One-step locking is standard on all side doors. The doors may be locked from the outside by simply depressing the inside door lock control button, and then closing the door. With the incorporation of the outside recessed door handles, depressing a push-button for locking is no longer required.

The inside door pull handle is formed as an integral part of the armrest. The operating handle is a "paddle-shape" and actuates the door latch when pulled outward with the fingertips. The design provides protection against accidental opening by passengers.

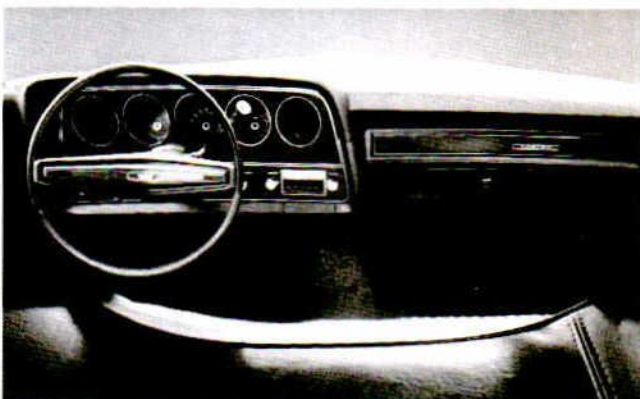

INSTRUMENT PANEL

The 1974 Torino Instrument Panel construction utilizes best characteristics of both steel and plastic to provide energy-absorbing capability. Plastic is framed on sheet metal and covered by a one-piece injection molded energy-absorbing facing with a leatherlike vinyl texture. The vinyl pad is color-keyed to the trim selection. A large glove box with a molded door and safety-type twist open latch is placed on the right side.

The control panel in front of the driver contains a row of pods which house the following:

The center pod is the speedometer. The next left pod contains the fuel gauge, left turn signal, high beam and alternator warning light. The pod to the right of center houses the temperature gauge, brake warning system light, the oil pressure warning light and the right-hand turn signal. The extreme left-hand pod is the DirectAire ventilating duct and the right-hand pod is a provision for the standard electric clock on the Brougham model or an optional electric clock on other models.

On Gran Torino Sport models a performance cluster is standard. This feature includes a tachometer, trip odometer and the following engine gauges: FUEL, AMPERE, TEMP. and OIL. An electric clock is also included.

The section of the panel on the left of the steering column contains the light switch and heater controls. The illuminated windshield wiper/washer switch and radio are to the right. The ashtray with cigarette lighter is below the radio.

HEATING

Torino's high capacity heater uses the blend air principle of temperature control. Temperature is controlled by regulating the amount of air that passes through the heater core.

Heat, defrost, and temperature controls, and the three-speed biower switch are located under the front edge of the instrument cluster within easy reach of the driver. The defroster lever ducts air to slit-type openings on the instrument panel to defog the windshield.

TORINO FEATURES

DIRECTAIRE VENTILATION

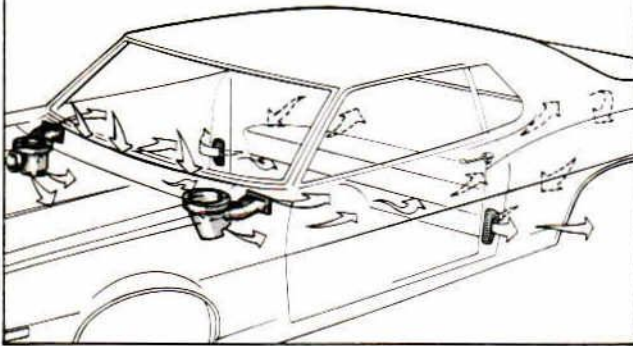

VENTILATION

Standard in all Torinos is DirectAire ventilation. This system provides air flow through the vehicle with the windows closed. The DirectAire system provides for both high and low outlets in the front compartment and Flow-Thru pressure relief one-way exhaust valves in the door lock pillars.

With "DirectAire," two fully-adjustable air registers, one in each end of the instrument panel, are used. Also there are two outlets directed toward the toe board. These are the same registers as are used with the optional SelectAire air conditioning system. Air flow from the registers can be adjusted by rotating the barrel on the left or by moving the louvers on the right side of the instrument panel, or by directing the register up or down. The air can be shut off by moving the louver control to the extreme right. The distribution of air can also be controlled between the panel registers and the floor directed outlets by a pull rod.

With this ventilation system, air can enter from the concealed front intakes . . . circulate throughout the interior . . . and exit, carrying away stale or smoke-laden air . . . without any need to open a window.

FUSE PANEL

A fuse panel, located on the passenger compartment firewall to the right of the brake support, is designed to hold eleven fuses. This permits the maximum number of circuits used per fuse to be two, increasing overall electrical system reliability. The extra fuse location also simplifies diagnostic testing of the electrical system.

HOOD

All Torinos feature a hatch-type hood that is designed at the front to blend into the new sheet metal over the grille. Counter-balanced double-link hinges make the hood easy to open and close. Heavy coil springs assist in raising the hood and holding it open.

Rubber bumpers provide cushioning against squeaks and rattles. The bumpers are adjustable for leveling the hood with the front fenders and sheet metal over the grille.

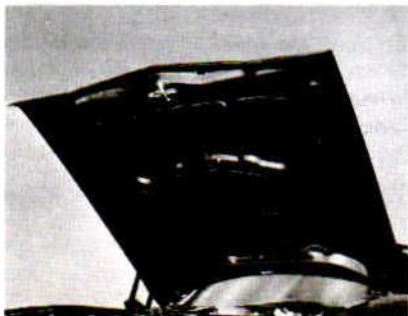

As an anti-theft measure, all Torino models feature an inside hood release as standard equipment. The release handle is below the left side of the instrument panel. Pulling the handle partially opens the hood which then permits access to an outside safety latch which must be released before the hood can be fully opened.

BUMPER JACK SYSTEM

The 1974 Torinos are equipped with a pin-and-slot bumper jack system. The design eliminates the hook that normally connects to the bottom of the bumper. Instead, a flat pin, integral with the ratchet mechanism, fits into slots pierced into the bumper. The system provides faster, simpler operation with more positive retention.

NEW GRILLE

The new grille used on the Gran Torino, Gran Torino Brougham, Gran Torino Sport and Gran Torino Squire models is bright and dark argent and features an oval, eight segmented design with an inner egg-crate pattern. The grille is redesigned from that used in 1973. Parking/turn signal lamps are behind the grille at the far outboard edges. The Gran Torino and Gran Torino Sport ornament is located left of the center of the grille. On Gran Torino Brougham and Gran Torino Squire (with Squire Brougham option) models, the Brougham ornament is located on the hood and is mounted with a spring-loaded fold-back device.

The Torino low-series grille extends almost full-width with the grille pattern surrounding the horizontal headlamps. The grille is painted light and dark argent to highlight the egg-crate texture. The parking turn signal lamps are in the leading edge of the fender extensions. A Torino ornament is at center grille.

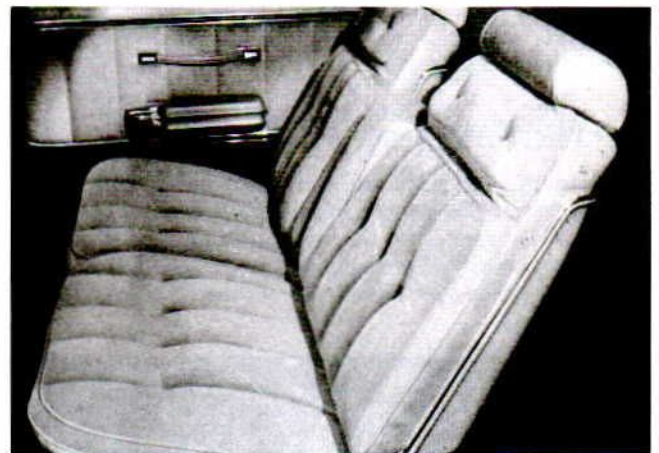

SEATS

For 1974, Gran Torino Brougham models feature comfortable individually adjustable split bench seats with dual fold-down center armrests. These styled seats include full-width head restraints. On Torino and Gran Torino models, seats are the low-back bench design with low-profile head restraints. Bucket seats are available on the Gran Torino Sport model, in lieu of Flight Bench seats at no cost.

Seat springs are attached to a rugged welded frame foundation. A burlap pad with interwoven wires is placed over the springs to provide a strong, yet smooth base for the seat padding. Front seats are covered with a molded urethane foam pad and rear seat cushions are constructed of extra heavy layers of cotton, except station wagons, which have a cotton and foam padding combination.

TORINO OPTIONS

Torino offers a wide variety of factory-installed options which are described here in detail and/or are listed on pages C-21, 22. Owners can select from these items to equip their car to suit their personal tastes.

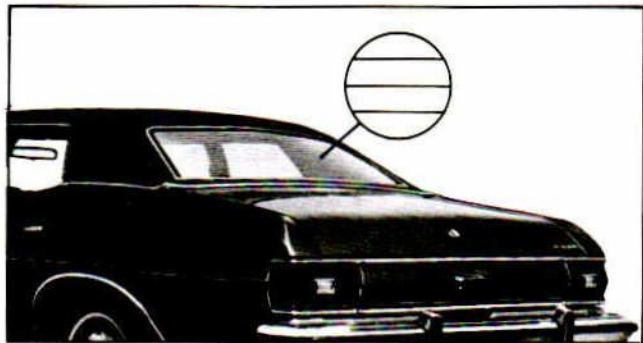

ELECTRIC REAR WINDOW DEFROSTER

This "Better Idea" option helps keep the backlite frost-free and will remove snow, frost, and up to $\frac{1}{8}$ -inch of ice in minutes. A high wattage output per square inch of glass area helps reduce the time required to defog the glass interior and provides more positive ice and snow melting capabilities. The heating unit is turned on by the "Accessory" switch on the instrument panel and consists of a silver-filled, ceramic, high-resistance printed electrical circuit, silk-screened onto the inside of the backlite.

While visible as a series of $\frac{1}{32}$ -inch wide lines across the full width of the backlite, the unit does not interfere with the driver's rear vision due to the wide spacing between the lines and a new subdued, less conspicuous dark red color. The electric rear window defroster is available on all passenger cars with V-8 engines.

The option also includes a 61- or 70-amp. alternator, depending on equipment.

ELECTRIC POWER DOOR LOCKS

This convenience option features all-electric operation. The front door lock buttons actuate switches connected to electric motor-driven servos in the doors. Raising either button unlocks all doors and lowering either button locks all doors. On station wagons, this option also includes a power lock for the doorgate.



TILT STEERING WHEEL

New for 1974, Torino's optional Tilt Steering Wheel allows the driver to select any one of five steering wheel angles by

pushing forward on the turn signal lever. When the car and engine are stopped, the wheel can be placed in the maximum "up" position for easy entry/exit.

"TRACTION-LOK" DIFFERENTIAL

Beneficial to family and performance cars alike, Ford's "Traction-Lok" differential is designed to lock the rear wheels together in proportion to the driving torque applied. Some of the major benefits of this option are: Extra traction on ice, mud or snow, and maximum accelerating power. (See the Power Teams section for more information.)

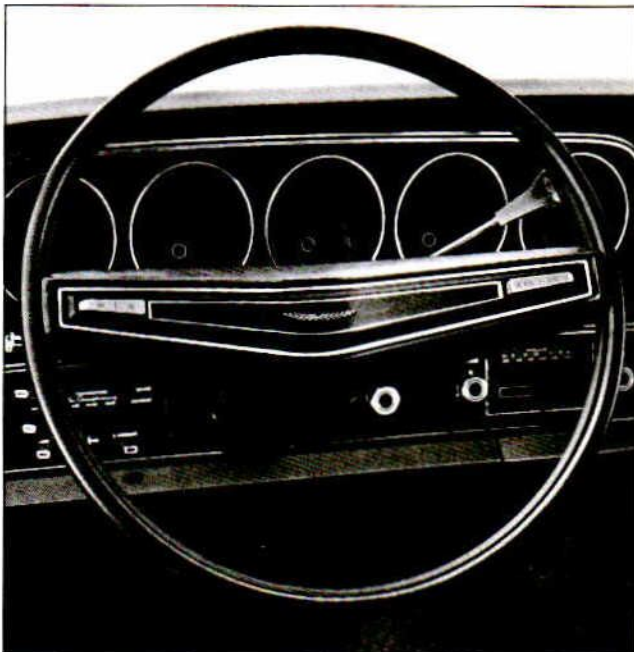

FINGERTIP SPEED CONTROL

The Fingertip Speed Control option regulates vehicle speed automatically and maintains a set speed at a desired level, until reset or turned off. The controls are conveniently located in the spokes of the two-spoke steering wheel.

The left spoke contains the "On-Off" rocker switch. The right spoke contains the "Set-Accel, Coast" rocker switch.

By depressing the "On" side of the rocker switch the system is activated. The driver can accelerate to the desired speed and by momentarily depressing and releasing the "Set-Accel" switch, the Automatic Speed control will take over at speeds above 30 mph. The car speed can also be increased by depressing the "Set-Accel" switch and holding it until the desired speed is reached. Release the switch and the control will resume automatic operation at the higher speed.

To lower the speed at which automatic control is desired, the "Coast" switch (right side of right rocker) is pressed and held. When this is done, the car gradually slows down. When a lower speed is reached, the switch is released, and the lower road speed is maintained.

The "Off" switch (left half of left rocker) deactivates the speed control system. This system can also be cancelled by slightly depressing either the brake pedal or by turning the ignition key to "Off." The option includes the "Rim-Blow" deluxe two-spoke steering wheel. A "Rim-Blow" deluxe three-spoke steering wheel is available as a separate option.

TORINO OPTIONS



AUTOMATIC TEMPERATURE CONTROL AIR CONDITIONING

Automatic Temperature Control with SelectAire air conditioning allows the Torino owner to control interior comfort during all seasons, by setting one control and forgetting it. In warm weather, cooling action begins as soon as the engine is started; in cold weather, heat is delayed until the engine is warm enough to provide good heating action, except on "defrost."

When window fogging or icing conditions are encountered, the SelectAire selector is moved manually to the "Defog" or "Defrost" position. Once the glass is clear, the lever may be turned to the automatic position and automatic temperature control takes over again.

The option also includes a "HI" blower feature designed to allow the driver or front seat passenger to increase the speed at which the car is cooled.

SELECTAIRE AIR CONDITIONING

The Torino SelectAire air conditioning unit, including controls, is fully integrated into the instrument panel and provides temperature and humidity controlled comfort with all windows closed.

The four-speed blower motor and two air conditioning positions give this unit maximum versatility. By placing the select lever on "A/C," air is circulated through vents in the instrument panel. A "HI/LO" position directs air through both the instrument panel vents and floor vents. A temperature control lever enables the operator to select the desired temperature.



DELUXE BUMPER GROUP

Attractive and functional, Torino's optional Deluxe Bumper Group helps prevent minor dents and scrapes to front and rear bumpers. The option includes full-width rub strip on the front and rear bumpers and durable scratch-resistant front and rear bumper guards with vertical rub strips (front bumper guards only on wagon models). Two additional bumper guard options are also available.

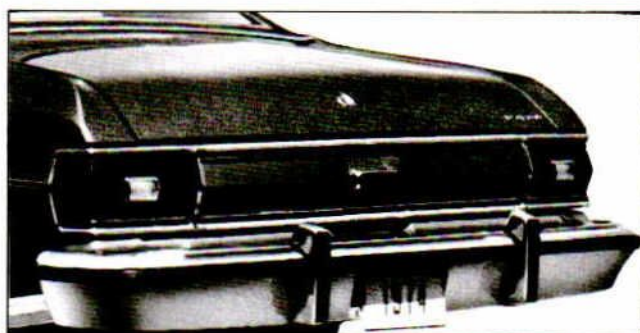

ANTI-THEFT ALARM SYSTEM

A major deterrent to vehicle theft and theft of vehicle contents is this new Anti-Theft Alarm System, optional on all 1974 Torinos. The system utilizes a solid-state electronic device, and when armed, senses any entry to the passenger or luggage compartment.

A switch attached to the front door lock-tumblers provides the method of arming and the electronic device provides the functions of sensing voltage differentials, activation, sounding the horn, timing, automatic shut-down and deactivation.

The system can be armed by locking either front door with the appropriate key. Once the system has been armed, opening any of the doors, trunk lid or station wagon doorgate will activate the alarm. NOTE: The system must be disarmed before the trunk lid or doorgate can be opened or the alarm will be activated. Unlocking either front door, with the proper key, will disarm the alarm. Once the alarm has been triggered, the system can be deactivated by inserting the key in either front door and turning to the unlock position. It can also be deactivated by inserting the key into the ignition and turning it to the "on" or "accessory" position. The system will continue sounding the horn intermittently for five to seven minutes unless it is deactivated in this manner.

The power for the alarm system is supplied by the battery. A locking hood release is included in the option to help prevent tampering with the battery. A spare tire lock is also included in the option to add additional protection against tire theft.

For customer convenience, there is a time delay of approximately ten seconds after arming until the alarm system is activated. This time delay allows sufficient time for all occupants to exit the vehicle.

VINYL INSERT BODYSIDE MOLDING

Attractive and functional, this option is designed to help protect bodyside sheet metal from scratches and minor dents. Vinyl inserts are black. When ordered in combination with the Squire option, vinyl inserts are brown. Gran Torino Brougham models feature bodyside molding with wide, color-keyed vinyl inserts as standard equipment.

LIGHT GROUP

Torino's Light Group includes a convenient dual beam map light unit in the roof. Two individually activated miniature map lights on either side of the dome light shine over the shoulders of driver and front seat passenger. Other features of the Light Group include ashtray light, glove compartment light, luggage compartment light (cargo light on station wagons), instrument panel courtesy light, engine compartment light, rear door courtesy light switches (4-door models), headlights "lights-on" warning buzzer, parking brake warning light, and headlight switch illumination.

TORINO OPTIONS

APPEARANCE PROTECTION GROUP

This option includes a new locking gas cap for 1974. This new feature protects against illegal tampering with the gas tank. A spare tire lock replaces the conventional hold-down wing nut on the spare tire and effectively prevents the removal of the unit. The Appearance Protection Group also includes front color-keyed floor mats, door edge guards and bright license plate frames. A vinyl insert bodyside molding to help protect doors from parking lot nicks and scratches is available as a separate option.

FENDER SKIRTS

These new fender skirts are made of corrosion-resistant durable plastic and help add a unique and stylish look to the 1974 Torino. Fender skirts are available on the 2- and 4-door Gran Torino Brougham, Gran Torino 2- and 4-door models and Gran Torino Sport model.

LEATHER-WRAPPED STEERING WHEEL

This option features a glove-soft color-keyed leather covering on the wheel rim of a deluxe two-spoke steering wheel. The covering is sewn with a fine hidden stitch.

CONVENIENCE GROUP

New for 1974, this group option combines popular features for driver and passenger comfort and convenience. Included are: left- and right-hand remote-control mirrors that allow easy adjustment of either mirror from the driver's seat. The front vanity visor mirror offers special passenger convenience. Interval windshield wipers reduce smearing and dry-wiping periods of light rain, mist or car spray. They can be adjusted to wipe at intervals up to ten seconds.

For station wagon owners, a new Spare Tire Extractor is included. It provides a convenient method of removing the spare tire from the wheel well in the right rear quarter panel. The extractor consists of a plastic sling, which is underneath the tire and fastened at the front of the spare tire well with a handle at the rear. Pulling up and to the left on the handle lifts the tire out of the well and onto the load floor.

AM RADIO

Torino's "mini"-size AM Radio option features reliable circuitry and excellent reception. The radio has a power output of four watts.

AM/FM STEREO RADIO

Torino's "mini"-size AM/FM stereo radio includes a circuitry with high sensitivity for retaining weak signals. The power output is four watts for excellent clarity and tonal range. The AM/FM stereo radio allows a choice of AM or FM stereo reception merely by moving the function selector switch. Stereo multiplex operation is indicated by an amber light on the radio faceplate. "5 x 10" push-button feature allows the five push buttons to be preset to provide five AM and five FM stations. Balance and fader controls allow exact blending of sound from the four-speaker system. Two front

speakers (one in each front door) and two package-tray mounted rear speakers are included with the AM/FM stereo radio.

AM/FM STEREO RADIO WITH TAPE PLAYER

A complete entertainment/sound system, the new AM/FM stereo radio with tape player, offers three modes of operation, AM, FM and tape. Four speakers provide true stereo reproduction and excellent sound clarity and tonal range. The tape segment of the unit accepts the popular eight-track cartridges. Insertion of the tape cartridge automatically shuts off the radio. Controls are provided for manual tuning, front-to-rear balance, volume, tone, and push-button radio selection.

METALLIC GLOW PAINT

Four optional "Metallic Glow" paints are available on the 1974 Torino in Green Glow, Gold Glow, Tan Glow and Ginger Glow.

These paints create the illusion of extra depth due to the control and size of the aluminum particles in the special paint formula. The clarity and transparency of the highly durable surface also contribute to the distinctive characteristics of these glamorous finishes.

VINYL ROOF

This option adds to the luxury appearance of Torino and provides a "customized" color-keyed accent to interior and exterior color and trim combinations. Standard on the Gran Torino Brougham, the vinyl roof is available in seven colors on all other models except wagons. (See page C-26 for vinyl roof trim combinations.)

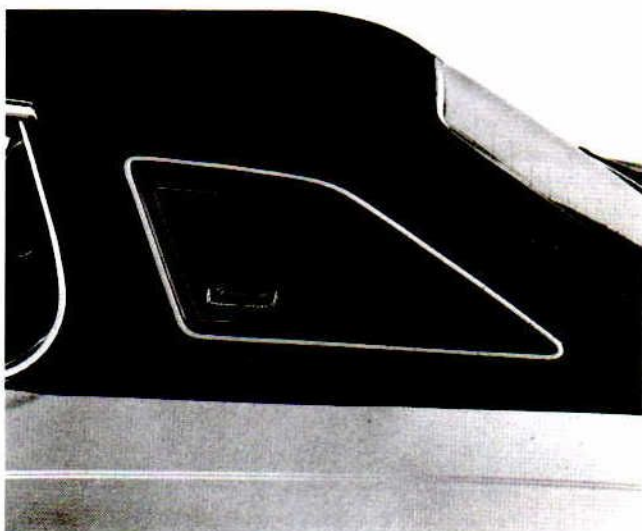

OPERA WINDOWS

The new opera windows add an elegant touch to the 1974 Torino. This unique trapezoid-shaped window is standard on the 2-door Gran Torino Brougham and available on the Gran Torino Sport and the 2-door Gran Torino. The addition of the opera window increases visibility for drivers and passengers and helps complement the profile of the rear pillar. The Brougham emblem is imprinted in the laminate between two layers of glass.

TORINO OPTIONS

TRAILER TOWING PACKAGES

Torino for '74 offers two trailer towing packages. A Medium-Duty package for Class II (up to 3500 pounds trailer weight with a maximum tongue load of 500 pounds) and a Heavy-Duty package for Class III (up to 6000 pounds trailer weight with a maximum tongue load of 700 pounds).

The Medium-Duty package includes Heavy-Duty Handling suspension, high axle ratio, extra-cooling package, wiring harness, and trailer towing identification plaque. (See the options listing on page 23 for component description.)

The Heavy-Duty package includes Heavy-Duty Handling suspension, coolant recovery system, heavy-duty frame (except station wagons), transmission oil cooler, extra-cooling package, wiring harness, trailer towing identification plaque, high ratio axle, heavy-duty alternator. (See options listing on page 23 for component description. Also see Trailer Towing Warranty Statement, page ii.)



POWER-OPERATED SUNROOF

A power-operated sunroof, located over the front compartment, is available on all 2-door Torino models with the optional vinyl roof and provides the open-air advantages of a convertible with the styling and security of a hardtop. The sunroof is powered by an electric motor which is actuated by a finger-tip control in the roof and slides back out of sight above the headliner. When closed, the sunroof matches the roofline and seals tightly in position, keeping the weather and noise outside.



BASE WHEEL COVER

This rust-resistant full wheel cover is standard on Gran Torino Squire. It is available as an option on all other models except Gran Torino Sport and Gran Torino Brougham.



DELUXE WHEEL COVER

The deluxe wheel cover is standard on the Gran Torino Brougham models. It is available as an option on all other models.

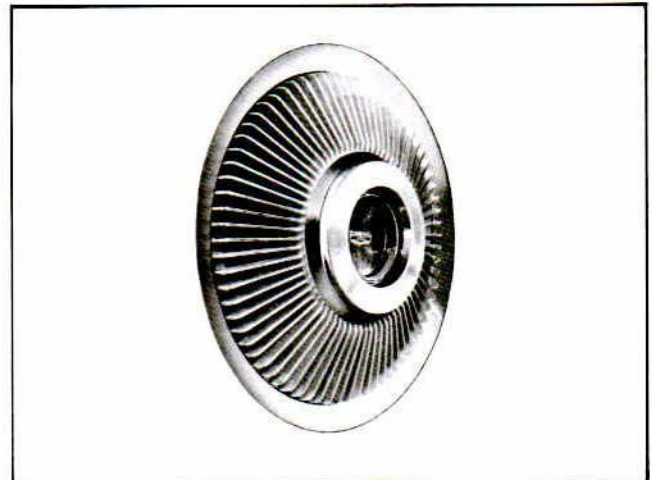

LUXURY WHEEL COVER

The luxury wheel cover is available as an option on all models.

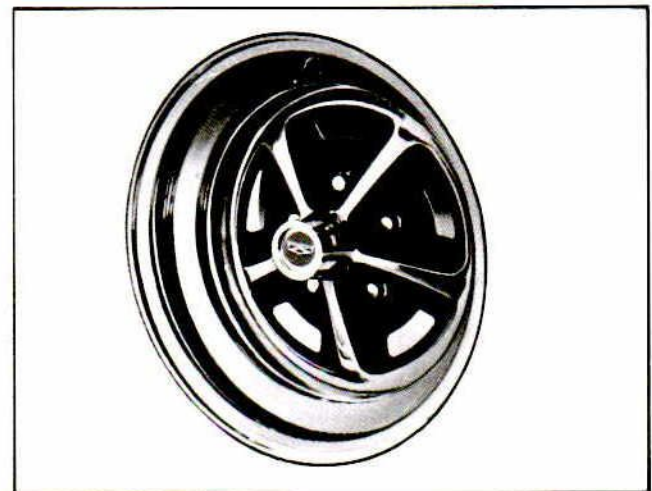

MAGNUM 500 WHEEL/TRIM RINGS

This racy-looking 14" Magnum 500 wheel with chrome trim rings is available as an option on all models except station wagons and models equipped with fender skirts.

TORINO OPTIONS AVAILABILITY

APPEARANCE/PROTECTION EQUIPMENT

- Accent Group (Includes full wheel lip moldings and dual fender peak paint stripes.) (Available only on Torino series models.) (NA station wagon.)
- Alarm System, Anti-Theft (Includes alarm, lockable inside hood release and spare tire lock.)
- Appearance Protection Group (Includes front color-keyed floor mats, door edge guards, spare tire locks, locking gas cap and bright license plate frames.) (Door edge guards are deleted when ordered on Gran Torino Squire models.)
- Belts, Color-Keyed Deluxe
- Bumper Group, Deluxe (Includes front and rear bumper guards with rubber inserts, full-width front and rear rub strips.)
- Bumper Guards, Front (Includes rubber inserts.)
- Bumper Guards, Rear (Includes rubber inserts.)
- Decor Group, Exterior (Includes fender peak paint stripe, deluxe wheel covers and vinyl roof.) (Available only on Gran Torino models.) (NA with base wheel covers.)
- Fender Skirts (Available only on Gran Torino Brougham, Gran Torino hardtop and pillared hardtop models and Sport model.) (Not available with wide oval tires or Mag 500 wheels.)
- Luggage Compartment Dress-Up (Includes carpeting, side lining boards and spare tire cover.) (Not available on station wagon models.)
- Moldings, Vinyl Insert Bodyside (Includes black vinyl insert, brown with Gran Torino Squire and Squire Brougham option.) (Color-keyed molding standard on Gran Torino Brougham models.)
- Opera Windows (Standard on Gran Torino Brougham 2-door hardtop.) (Available only on 2-door Gran Torino and Gran Torino Sport models.) (Requires vinyl roof at extra cost.)
- Paint, Metallic Glow (Available in green glow, gold glow, tan glow and ginger glow.)
- Paint Stripes, Dual Fender Peak (Standard on Gran Torino Sport model.) (Available only on Gran Torino Brougham models.) (Standard with exterior decor and accent group.)
- Paint/Tape Stripes Lower Bodyside (Available only on Gran Torino Sport or Gran Torino 2-door hardtop models.) (Standard rocker panel moldings deleted with this option.)
- Roof, Vinyl (Standard on Gran Torino Brougham models.) (NA on station wagon models.)
- Squire Brougham Option (Includes deluxe wheel covers, stand-up hood ornament, split bench front seat, super-soft vinyl seat/door trim, 25-oz. cut-pile carpeting in passenger compartments, cut-pile carpeted load floor, electric clock.)
- Wheel Covers (Standard on Gran Torino Squire model.) (NA on Gran Torino Sport and Gran Torino Brougham models or with Squire Brougham Option or exterior decor group.)
- Wheel Covers, Deluxe (Standard on Gran Torino Brougham model and with Squire Brougham Option and exterior decor group.)
- Wheel Covers, Luxury
- Wheel, Magnum 500/Trim Rings (NA on station wagons or with fender skirts.)

AUDIO EQUIPMENT

- Radio, AM
- Radio, AM/FM Stereo (Includes two front door-mounted speakers and dual rear-seat speakers.)
- Radio With Tape Player, AM/FM Stereo (Includes two front door-mounted speakers and dual rear-seat speakers.)
- Speakers, Dual Rear-Seat (Standard with AM/FM stereo radio with or without tape player.) (Available only with AM radio.)

COMFORT/CONVENIENCE EQUIPMENT

- Air Conditioner—SelectAire (Requires power steering at extra cost.) (Tinted glass—complete recommended.)

- Air Conditioner—SelectAire With Automatic Temperature Control (Not available on Torino series models.) (Requires power steering at extra cost.) (Tinted glass—complete recommended.)
- Carpeted Station Wagon Cargo Area (Not available with Squire Brougham Option.)
- Convenience Group (Includes LH and RH outside chrome remote-control mirrors (except on Sport model), vanity visor mirror and interval windshield wipers.) (Station wagon models also include spare tire extractor.)
- Clock, Electric (Standard on Gran Torino Brougham, Gran Torino Sport models and with Squire Brougham option.)
- Console (Available only with bucket seats on Gran Torino Sport model.)
- Electric Rear Window Defroster
- Glass, Tinted—Complete (Recommended with air conditioner.)
- Light Group (Includes ash tray light, dome/map light, glove compartment light, luggage compartment light on passenger car/cargo light on station wagons, instrument panel courtesy light, engine compartment light, rear door courtesy light switches on 4-door models, headlights "lights-on" warning buzzer, headlight switch illumination, and parking brake warning light.)
- Luggage Rack, Deluxe (Includes integral rear window air deflector and adjustable rear cross bar.) (Available only on station wagon models.)
- Mirrors, Outside Color-Keyed Remote-Control (Includes left-hand and right-hand remote-control mirrors.) (Standard on Gran Torino Sport model.) (Not available with special paint, DSO or PTO)
- Mirror, Outside Left-Hand Remote-Control (Not available on Gran Torino Sport model.)
- Seat Back Release, Automatic
- Seats, Bucket (Available only on Gran Torino Sport model as a no cost option.)
- Seat, Rear Facing Third (Available only on Gran Torino and Gran Torino Squire station wagon models.)
- Speed Control, Fingertip (Includes deluxe two-spoke steering wheel.) (Available only with 351 CID 2V, 400 CID 2V or 460 4V engines.)
- Steering Wheel, Rim-Blow Deluxe Three-Spoke
- Steering Wheel, Leather-Wrapped
- Sunroof, Power-Operated (Available only on 2-door models.) (Requires vinyl roof at extra cost.)
- Trim, Pleated Vinyl Seat (Standard on Gran Torino and Gran Torino Squire station wagon models.) (Available only on Gran Torino hardtop or pillared hardtop models.)
- Trim, Super-Soft Vinyl (Standard on Gran Torino Sport model and with Squire Brougham Option.) (Available only on Gran Torino Brougham models as a no cost option.)

ENGINES/TRANSMISSIONS

- 351 CID 2V 8-Cylinder (Requires Cruise-O-Matic transmission, power steering, and power front disc brakes at extra cost.)
- 351 CID 4V 8-Cylinder (Includes 55-amp. hr. battery, special intake manifold, special valve springs with dampers, large capacity 4300-D carburetor, modified camshaft, and four-bolt main bearing caps.) (Available only on 2-door models.) (Requires Cruise-O-Matic, power steering and power front disc brakes at extra cost.)
- 400 CID 2V 8-Cylinder (Includes 68-amp. hr. heavy-duty battery.) (Requires Cruise-O-Matic transmission, power steering and power front disc brakes at extra cost.)
- 460 CID 4V 8-Cylinder (Requires Cruise-O-Matic transmission, power steering and power front disc brakes at extra cost.)
- SelectShift Cruise-O-Matic (Standard on station wagon models.) (Required at extra cost on models equipped with 351 CID 2V, 400 CID 2V, or 460 CID 4V engines.)

TORINO OPTIONS AVAILABILITY

SPECIAL HEAVY-DUTY EQUIPMENT

Axle, Optional Ratio

Axle, Traction-Lok Differential

Battery, Heavy-Duty—68-Amp. hr. (Standard with 351 CID 2V with air conditioner, 400 CID 2V, 460 CID 4V.)

Suspension, Heavy-Duty/Handling (Includes heavy-duty front and rear springs.) (Hardtop and pillared hardtop models also include heavy-duty shock absorbers and rear stabilizer bar.) (Standard with trailer towing packages.)

Trailer Towing Package—Class II (Includes heavy-duty/handling suspension, higher ratio axle, extra-cooling package, wiring harness, and trailer towing identification plaque.) (Requires 351 CID 2V or 460 CID 4V engine, Cruise-O-Matic transmission, power steering and power front disc brakes at extra cost.)

Trailer Towing Package—Class III (Includes heavy-duty alternator, heavy-duty frame, wiring harness, heavy-duty/handling suspension, higher ratio axle, transmission oil cooler, extra-cooling package, coolant recovery system and trailer towing identification plaque.) (Requires 460 CID 4V engine, Cruise-O-Matic transmission, power steering, power front disc brakes, and H78 or larger tires at extra cost.)

POWER ASSISTS

Power Door Locks, Electric (Includes power tailgate lock on station wagon models.)

Power Front Disc Brakes (Standard on station wagon models.) (Required at extra cost on models equipped with 351 CID 2V or larger engine.)

Power Seat—6-Way Driver Only (Available only with split bench seat.)

Power Seat—6-Way Full-Width (Not available on Gran Torino Brougham models or Squire Brougham option.)

Power Side Windows (Includes front windows only on 2-door models.)

Power Steering (Required at extra cost on models equipped with 302 CID 2V engine in combination with air conditioner. Also required at extra cost on models equipped with 351 CID 2V or larger engine.)

Power Tailgate Window (Standard on Gran Torino Squire wagon.) (Available only on Torino and Gran Torino station wagon models.)

TIRES

G78 x 14 WSW

H70 x 14 B/WL

H78 x 14 BSW

HR78 x 14 steel-belted radial ply WSW

H78 x 14 WSW

TORINO GENERAL SPECIFICATIONS

1974 TORINO STANDARD TIRE AVAILABILITY

MODEL AND ENGINE APPLICATION	302 CID 2V 8-CYLINDER	351 CID 2V 8-CYLINDER	351 CID 4V 8-CYLINDER	400 CID 2V 8-CYLINDER	460 CID 4V 8-CYLINDER
TORINO					
2-Door Hardtop-Formal Roof	G78 BSW	G78 BSW	G78 BSW	G78 BSW (a)	H78 BSW
4-Door Pillared Hardtop	G78 BSW	G78 BSW (a)	N/A	G78 BSW (a)	H78 BSW
4-Door Station Wagon	H78 BSW	H78 BSW	N/A	H78 BSW	H78 BSW
GRAN TORINO					
2-Door Hardtop-Formal Roof	G78 BSW	G78 BSW (a)	G78 BSW (a)	G78 BSW (a)	H78 BSW
4-Door Pillared Hardtop	G78 BSW	G78 BSW (a)	N/A	G78 BSW (a)	H78 BSW
4-Door Station Wagon	H78 BSW	H78 BSW	N/A	H78 BSW	H78 BSW
GRAN TORINO BROUGHAM					
2-Door Hardtop-Formal Roof	HR78 WSW	HR78 WSW	HR78 WSW	HR78 WSW	HR78 WSW
4-Door Pillared Hardtop	HR78 WSW	HR78 WSW	N/A	HR78 WSW	HR78 WSW
GRAN TORINO SQUIRE					
4-Door Squire Station Wagon	HR78 WSW	HR78 WSW	N/A	HR78 WSW	HR78 WSW
GRAN TORINO SPORT					
2-Door Hardtop-Formal Roof	HR78 WSW	HR78 WSW	HR78 WSW	HR78 WSW	HR78 WSW

HR—steel-belted radial ply tires.

(a) H78 BSW standard on models with air conditioner.

OPTIONAL TIRE AVAILABILITY

Standard Tire	Optional Tire				
	G78 WSW	H78 BSW	H78 WSW	H70 B/WL	HR78 WSW
G78	X	X	X	X	X
H78			X	X	X
HR78		X	X	X(a)	

HR—steel-belted radial ply tires.

B/WL—black sidewall with raised white letters.

(a)—Gran Torino Sport only.

TORINO GENERAL SPECIFICATIONS

TORINO POWER TEAM SELECTIONS

Engine	TRANSMISSION		REAR AXLE RATIOS					
	3-Speed	Cruise-O-Matic	3-SPEED MANUAL			CRUISE-O-MATIC		
			Std.	Opt.	Traction-Lok	Std.	Opt.	Traction-Lok

ALL MODELS EXCEPT STATION WAGONS

302 CID 2V (b) V-8	Std.	Opt.	3.00*	NA	3.00*	3.00*	NA	3.00*
351 CID 2V V-8 Opt.	NA	(2) Opt.	NA	NA	NA	2.75* (a) (3)	3.25*	2.75* (a) 3.25*
351 CID 4V (b) V-8 Opt. (1)	NA	(2) Opt.	NA	NA	NA	3.25*	NA	3.25*
400 CID 2V V-8 Opt.	NA	(2) Opt.	NA	NA	NA	2.75* (a)	3.25* (a)	3.25* (a) 2.75* (a)
460 CID 4V V-8 Opt.	NA	(2) Opt.	NA	NA	NA	2.75* (a)	3.25* (a)	3.25* (a) 2.75* (a)

*Available transmissions and ratios with air conditioning. (a) 3.00 Standard in California
 (1) Available only on two-door models. (2) Required Option. (b) NA California
 (3) 3.00 standard on four-door models with 351 CID engine. NA—Not Available

STATION WAGONS

302 CID 2V (b) V-8 Std.	NA	Std.	NA	NA	NA	3.00*	NA	3.00*
351 CID 2V V-8 Opt.	NA	(2) Opt.	NA	NA	NA	3.00*	3.25* (a)	3.00* 3.25*
400 CID 2V V-8 Opt.	NA	(2) Opt.	NA	NA	NA	2.75* (a)	3.25* (a)	2.75* (a) 3.25* (a)
460 CID 4V V-8 Opt.	NA	(2) Opt.	NA	NA	NA	2.75* (a)	3.25* (a)	2.75* (a) 3.25* (a)

*Available transmissions and ratios with air conditioning. (a) 3.00 Standard in California
 (1) Available only on two-door models. (b) NA California
 (2) Required Option. NA—Not Available.

WHEEL SPECIFICATIONS

Type	Stamped Steel Ventilated Disc with Safety-Type Rims
Number of Studs	5
Diameter and Rim Width Standard Models	14" x 5.5"
Models using G70, and H70 x 14	14" x 6.0"
Optional 14" x 7.0" Magnum Wheels ... all models, except Station Wagons. (NA with fender skirts.)	

STEERING SPECIFICATIONS

Linkage Type	Parallelogram with Cross-Link and Idler Arm
Gear Type	Recirculating Ball and Nut-Type
Overall Steering Ratio	
—Manual	30.7:1
—Power	21.8:1
Turning Diameter (Curb-to-Curb)	
—(2-Door)	41.0 ft.
—(4-Door)	N.A.
Steering Wheel Diameter	15.0 x 15.5-inch
Steering Wheel Turns (Lock-to-Lock)—Manual	5.09
—Power	3.5

BRAKE SPECIFICATIONS

FRONT DISC/ REAR DRUM	ALL SEDANS	ALL STATION WAGONS
Brake Rotor Dia. (Disc)	10.72	10.72
Outer Working Surface Dia.	10.72	10.72
Inner Working Surface Dia.	6.785	6.785
Front Swept Area*	211.9 sq. in.	211.9 sq. in.
Drum Diameter/Width	10 x 2.5	11 x 2.25
Rear Swept Area*	157 sq. in.	155 sq. in.
Total Front and Rear Swept Area*	368.9 sq. in.	366.9 sq. in.
Lining Material	Molded Asbestos	
Lining Attachment	Riveted	
Parking Brake—Type	Mechanical Application of Rear Brakes	

*Swept Area is the effective working surface. Power Brakes standard on Station Wagons.

TORINO GENERAL SPECIFICATIONS

BODY DIMENSIONS

TORINO MODEL	4-Door Pillared Hardtop		2-Door Hardtop		Station Wagons	
	Low Series	High Series	Low Series	High Series	Low Series	High Series
All dimensions are in inches unless otherwise specified.						
GENERAL						
Wheelbase	118	118	114	114	118	118 †
Tread—Front	63.4	63.4	63.4	63.4	63.4	63.4
—Rear	63.5	63.5	63.5	63.5	63.5	63.5
Height—Overall	53.5	53.5	52.8	52.8**	54.9	54.9
Length—Overall	215.4	217.6	211.4	213.6	219.1	221.3
Width—Overall	79.3	79.3	79.3	79.3	79.0	79.0
—At center pillar	76.8	76.8	77.2	77.2	76.8	76.8
FRONT DOOR ENTRANCE ROOM						
Door opening height (scuff plate to windcord)	36.7	36.7	36.7	36.7	36.8	36.8
Foot clearance	15.1	15.1	15.1	15.1	15.1	15.0
Entrance height (seat to windcord)	30.4	30.0	30.4	30.0	30.4	30.0
REAR DOOR ENTRANCE ROOM						
Door opening height (scuff plate to windcord)	36.4	36.4	—	—	36.5	36.5
Foot clearance	11.2	11.2	—	—	13.0	12.8
Entrance height (seat to windcord)	29.7	29.7	—	—	29.2	29.2
FRONT SEAT ROOM						
Head room (effective)	38.4	38.1	37.7	37.4	38.5	38.2
Maximum leg room to accelerator	42.5	42.1	42.5	42.1	42.5	42.1
Hip room	59.4	59.4	59.4	59.4	59.4	59.4
Shoulder room	58.6	58.6	58.6	58.6	58.6	58.6
Steering wheel to thigh clearance	4.0	3.4	4.0	3.6	4.0	3.6
REAR SEAT (OR WAGON 2ND SEAT)						
Head room (effective)	37.1	37.1	36.3	36.3	38.5	38.4
Minimum effective leg room	37.8	37.5	33.2	33.0	37.3	37.1
Hip room	59.4	59.4	58.0	58.0	59.3	59.3
Shoulder room	58.4	58.4	56.9	56.9	58.4	58.4
3RD SEAT ROOM						
Head room (effective)	—	—	—	—	37.4	37.4
Leg room (effective)	—	—	—	—	31.1	31.1
Hip room	—	—	—	—	38.0	38.0
Shoulder room	—	—	—	—	48.4	48.4
LUGGAGE COMPARTMENT						
Usable luggage capacity (cu. ft.)	16.5	16.5	16.5	16.5	—	—
Lift-over height	29.4	29.4	28.3	28.3	—	—
CARGO COMPARTMENT						
Cargo Volume (cu. ft.)	—	—	—	—	84.9*	84.9*
Maximum floor length (open tailgate)	—	—	—	—	109.5	109.5
Load floor length (closed tailgate)	—	—	—	—	87.5	87.5
Maximum rear opening width	—	—	—	—	51.0	51.0
Rear opening height	—	—	—	—	28.8	28.8
Minimum floor width (between wheelhousings)	—	—	—	—	48.2	48.2
GLASS AREA (Sq. In.)						
Windshield glass exposed surface area	1383.8	1383.8	1383.8	1383.8	1383.8	1383.8
Side glass exposed surface area	1307.5	1307.5	1104.5	1104.5	2370.2	2370.2
Backlight glass exposed surface area	887.0	887.0	887.0	887.0	577.4	577.4
Total glass exposed surface area	3578.3	3578.3	3376.1	3375.3	4322.8	4322.8
CURB WEIGHT (Pounds)						
302-2V, Automatic Transmission	3975	4030	3900	3940	4360	4400†

*Additional 8.1 cubic feet for underfloor stowage

†Squire 4440

**Gran Torino Sport 52.4

TORINO COLOR AND TRIM

Charts shown reflect the color and trim combinations. Exterior colors and codes are in the first chart and the trim combinations follow. Colors and codes referenced are the same as those shown in your Color and Trim Book.

TORINO			
EXTERIOR COLORS AND CODES			
Color	Code	Color	Code
White	9A	Medium Copper Metallic	5M
Bright Red	2B	Saddle Bronze Metallic	5T
Dark Blue Metallic	3G	Dark Olive Gold Metallic	6M
Medium Blue Metallic	3D	Medium Ivy Yellow	6N
Medium Pastel Blue	3Q	Green Glow	4T*
Dark Green Metallic	4Q	Ginger Glow	5J*
Bright Green Gold Metallic	4B	Gold Glow	6F*
Pastel Lime	4A	Tan Glow	5U*

*Extra Cost Metallic Glow Paint

ALL TORINO (LOW SERIES)		
ALL VINYL—STANDARD		
Interior Trims		Exterior Color Availability Codes
Color	Code	
Black	AA	9A, 2B, 4A, 4B, 4Q, 4T, 5M, 6F, 6M, 6N
Medium Blue	AB	9A, 3D, 3G, 3Q
Medium Green (Torino Wagon)	AR	9A, 4A, 4B, 4Q, 4T
Lt. Tan*	AU	9A, 4Q, 5J, 5M, 5T, 5U, 2B

*N.A. On Station Wagons

GRAN TORINO 2-DOOR AND 4-DOOR HARDTOP		
CLOTH AND VINYL—STANDARD		
Interior Trims		Exterior Color Availability Codes
Color	Code	
Black	BA	9A, 2B, 4A, 4B, 4Q, 4T, 5M, 6F, 6M, 6N
Medium Blue	BB	9A, 3D, 3G, 3Q
Medium Green	BR	9A, 4A, 4B, 4Q, 4T
Lt. Tan	BU	9A, 4Q, 5J, 5M, 5T, 5U
Medium Saddle	BZ	9A, 5J, 5M, 5T, 5U, 6F

GRAN TORINO		
PLEATED VINYL OPTION*		
Color	Code	Availability Codes
Black	CA	9A, 2B, 4A, 4B, 4Q, 4T, 5M, 6F, 6M, 6N
Medium Blue	CB	9A, 3D, 3G, 3Q
Medium Green	CR	9A, 4A, 4B, 4Q, 4T
Lt. Tan	CU	9A, 4Q, 5J, 5M, 5T, 5U, 2B
Medium Saddle	CZ	9A, 5J, 5M, 5T, 5U, 6F
White with Black*	CW	9A, 2B
White with Blue*	CQ	9A, 3D, 3G, 3Q,
White with Green*	C5	9A, 4A, 4B, 4Q, 4T
White with Gold*	C8	9A, 6F, 6M, 6N
White with Saddle*	C9	9A, 5J, 5M, 5T, 5U

*N.A. on Gran Torino Wagon

**Available on 2-door models—Availability to be delayed.

GRAN TORINO SPORT		
ALL-VINYL BUCKET SEAT—OPTION		
Color	Code	Availability Codes
Black/Vermillion	DA	9A, 2B
Med. Blue/Lt. Blue	DB	9A, 3D, 3G, 3Q
Lt. Tan/Orange	DU	9A, 4Q, 5J, 5M, 5T, 5U, 2B

GRAN TORINO SPORT		
ALL-VINYL FLIGHT BENCH—STANDARD		
Color	Code	Availability Codes
Black/Vermillion	EA	9A, 2B
Med. Blue/Lt. Blue	EB	9A, 3D, 3G, 3Q
Lt. Tan/Orange	EU	9A, 4Q, 5J, 5M, 5T, 5U, 2B
White with Black*	EW	9A, 2B
White with Blue*	EQ	9A, 3D, 3G, 3Q
White with Saddle*	E9	9A, 5J, 5M, 5T, 5U

*Availability to be delayed.

GRAN TORINO BROUGHAM		
CLOTH AND VINYL SPLIT BENCH—STANDARD		
Color	Code	Availability Codes
Medium Blue	FB	9A, 3D, 3G, 3Q
Med. Lt. Tan	FU	9A, 4Q, 5J, 5M, 5T, 5U, 2B
Med. Lt. Gold	FY	9A, 4A, 6F, 6M, 6N

TORINO COLOR AND TRIM

GRAN TORINO BROUGHAM SUPER-SOFT VINYL SPLIT BENCH—OPTION

Color	Code	Availability Codes
Medium Blue	GB	9A, 3D, 3G, 3Q
Lt. Tan	GU	9A,4Q,5J,5M,5T,5U,2B
Lt. Gold	GY	9A, 4A, 6F, 6M, 6N

GRAN TORINO SQUIRE PLEATED VINYL—STANDARD

Color	Code	Availability Codes
Black	HA	9A, 2B, 4A, 4B, 4Q, 4T, 5M, 6F, 6M, 6N
Medium Blue	HB	9A, 3D, 3G, 3Q
Medium Green	HR	9A, 4A, 4B, 4Q, 4T
Medium Saddle	HZ	9A, 5J, 5M, 5T, 5U, 6F

GRAN TORINO SQUIRE SQUIRE BROUGHAM OPTION SUPER-SOFT VINYL SPLIT BENCH

Color	Code	Availability Codes
Black	GA	9A, 2B, 4A, 4B, 4Q, 4T, 5M, 6F, 6M, 6N
Medium Blue	GB	9A, 3D, 3G, 3Q
Medium Green	GR	9A, 4A, 4B, 4Q, 4T
Medium Saddle	GZ	9A, 5J, 5M, 5T, 5U, 6F

VINYL ROOF*

Roof Color	Code	Exterior Color Code
Black	A	9A, 2B, 4A, 4B, 4Q, 4T, 5M, 6F, 6M, 6N
White	W	All
Blue	B	9A, 3D, 3G, 3Q
Green	R	9A, 4A, 4Q, 4T
Tan	U	9A, 5J, 5M, 5T, 5U
Gold	Y	9A, 4A, 6F, 6M, 6N
Brown	T	9A, 5J, 5M, 5T, 5U, 6F

*Gran Torino Brougham bodyside molding color-keyed to roof color.